

## 1. Destination:

Due to its design, the **ARAD2N** enclosure is intended for mounting inside RACK 19" cabinets, with depths of 600 – 1000mm, 19" standard. This general-purpose enclosure may serve as an auxiliary element for integrating CCTV, AC, I&HAS, RTV, LAN systems in RACK 19" cabinets. It is intended for mounting:

- control panel and optionally additional modules
- access control controllers with optional modules
- other dedicated devices
- power supply units
- battery

## 2. Specifications:

**Table 1. Electrical parameters.**

<b>Tamper switch protection</b>	1 x microswitch: enclosure opening 0,5 A; 50 V DC max. NC – normally closed contacts
<b>Protection class EN 62368-1</b>	I (first)
<b>Rated current of protective connection</b>	6 A max
<b>Declarations, warranty</b>	CE, 2 years

**Table 2. Mechanical parameters.**

<b>Mounting dimensions</b>	W=19", H=2U
<b>Enclosure dimensions</b>	W=415, H=87, D=400 [+/-2 mm]
<b>Mounting plate</b>	W=368, H=358 [+/-2 mm]
<b>Recommended battery/batteries</b>	17 Ah / 12 V (SLA)
<b>Material</b>	Sheet metal DC01, thick: 1 mm Protection anticorrosion Color: RAL 9005 - black
<b>Closing</b>	Bolted: 2x M3
<b>Destination</b>	Inside
<b>Net/gross weight</b>	5.30 / 5.81 [kg]
<b>Notes</b>	front mounting, 4 M6 screws + cage nuts included possible mount by using ARAS...N rails – additional accessory

**Table 3. Operating parameters.**

<b>Protection grade EN60529</b>	IP20
<b>Operating temperature</b>	-10°C ...+40°C
<b>Storage temperature</b>	-20°C ...+60°C
<b>Relative humidity</b>	20%...90%, without condensation
<b>Sinusoidal vibrations during operation</b>	unacceptable
<b>Impulse waves during operation</b>	
<b>Direct insolation</b>	
<b>Vibrations and impulse waves during transport</b>	According to PN-83/T-42106



### 3. Product description

The enclosure is equipped with a mounting plate for mounting electronics/transformers/power supply units. The enclosure can accommodate a 17Ah/12V battery. It features tampering protection (against unwanted opening). To enable leading cables into the enclosure, one can buy a cable protection conduit of any length and a cable gland. The conduits and the cable glands are available at the following codes:

- 1) **ARAP16P** – cable gland, inside diameter 16 mm – connection between the protection conduit and the enclosure
- 2) **ARAP21P** – cable gland, inside diameter 21 mm – connection between the protection conduit and the enclosure
- 3) **MM019** – cable protection conduit , inside diameter 16 mm
- 4) **MM020** – cable protection conduit , inside diameter 21 mm

The **ARAD2N** enclosure has a space for up to 2x ARAP16P and 3x ARAP21P cable glands

Optionally, ARAW45 fans can be mounted. They trigger airflow inside the enclosure after exceeding 45°C. One enclosure can accommodate max. two fan units in the rear part of the enclosure.



Figure 1. View of enclosure.

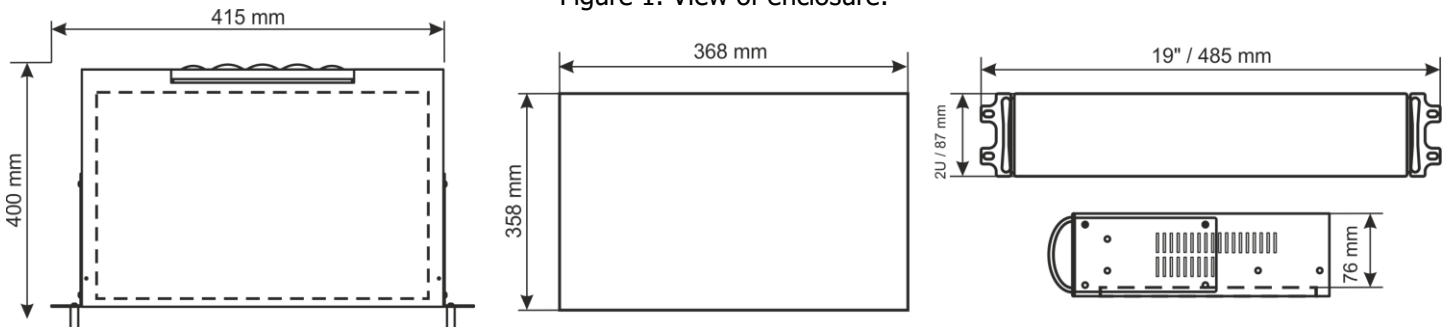

Figure 2. Dimensions.

### 4. Installation

The **ARAD2N** enclosure can be mounted in two ways:

- 4.1 Mounting without the ARAS600N/800N/1000N rails, no extension slide, the front part is the load-bearing part of the enclosure.



4.2 Mounting with the ARAS600N/800N/1000N rails - full extension slide of the RACK cabinet, rails of the ARAS... series are the load-bearing part of the enclosure.

Mount cage nuts for M6 screws in the RACK cabinet, as shown in Figure below, and mount the ARAS rails. Make sure that the rail is correctly mounted horizontally and its length between the front and rear RACK profile is properly adjusted.



Remove slider and tighten it to ARAD enclosure (M4 screw + washer). The enclosure is to be fixed to the front part of the RACK rails with four M6 screws.



Remove slider from ARAS rail

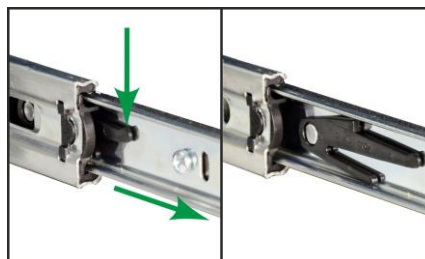

Remove slider



Remove the first M4 screw from ARAD enclosure



Fasten the sliders with two screws to ARAD enclosure (do not forget spacer washer under the second screw)

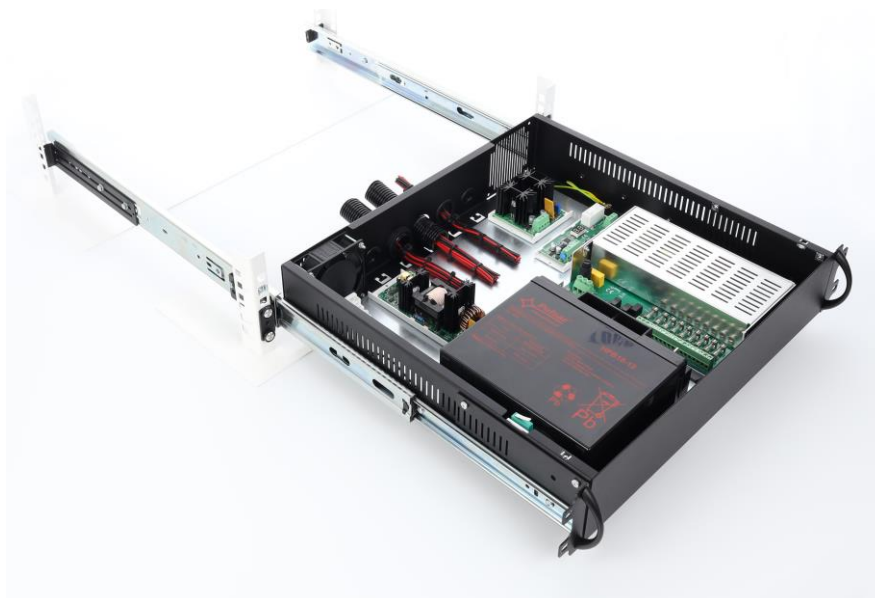

Slide enclosure with sliders into the rails installed in 19" RACK cabinet

## 5. Accessories:

### Enclosed power supply units / Transformers



### The ARAW45 fan

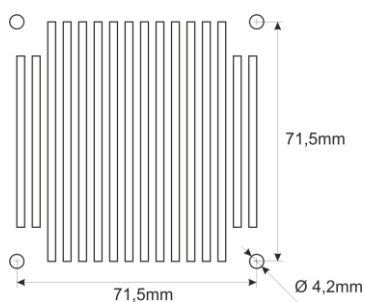
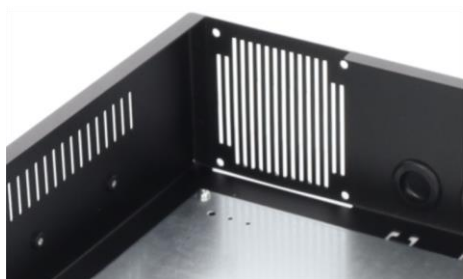

### Cable glands and protection tubes

Wires can be introduced in three ways:

- Through rubber grommets,
- Using the MM019/MM020 protection tubes,
- Using the MM019/MM020 protection tubes and the ARAP16P/ARAP21P cable glands.

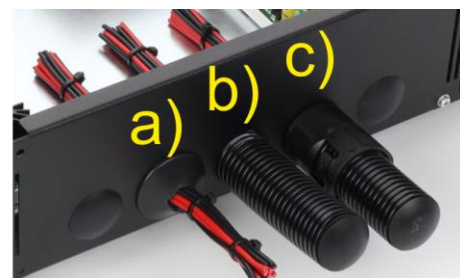
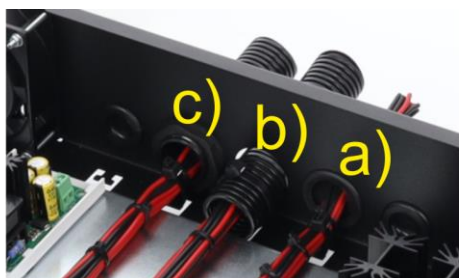



#### WEEE LABEL

Waste electrical and electronic equipment must not be disposed of with normal household waste. According to the European Union WEEE Directive, waste electrical and electronic equipment should be disposed of separately from normal household waste.



**CAUTION!** Device works with a lead-acid battery (SLA). After the operation period they must not be thrown but recycled according to the applicable law.

#### Pulsar sp. j.

Siedlec 150,  
32-744 Łapczyca, Poland  
Tel. (+48) 14-610-19-45  
e-mail: [sales@pulsar.pl](mailto:sales@pulsar.pl)  
[http:// www.pulsar.pl](http://www.pulsar.pl)

Facebook



LinkedIn



YouTube



Pulsar.pl

