



# AWZ632

v.1.0

## Battery controller 12VDC/20A

EN\*

Edition: 2 from 25.11.2022

Supersedes edition: 1 from 22.10.2018

:



### The battery controller features:

- Microprocessor-based automation system
- Automatic battery test every 5 min.
- The measurement of the resistance of the battery circuit
- Monitoring of the continuity of the battery circuit
- Battery Detection
- Low battery voltage indication - DC operation
- Battery output protection against short-circuit and reverse polarity connection
- Battery compartment for 7 ÷ 65 Ah / 12 V (SLA) batteries
- Technical output of failure - relay type
- Optical indication of failure (LED)
- Acoustic indication of failure
- "Test" button is at the front panel
- Designed to operate with a 13,8 V uninterruptible power supply unit
- Warranty: 2 years from production date

### An example of use battery controller.

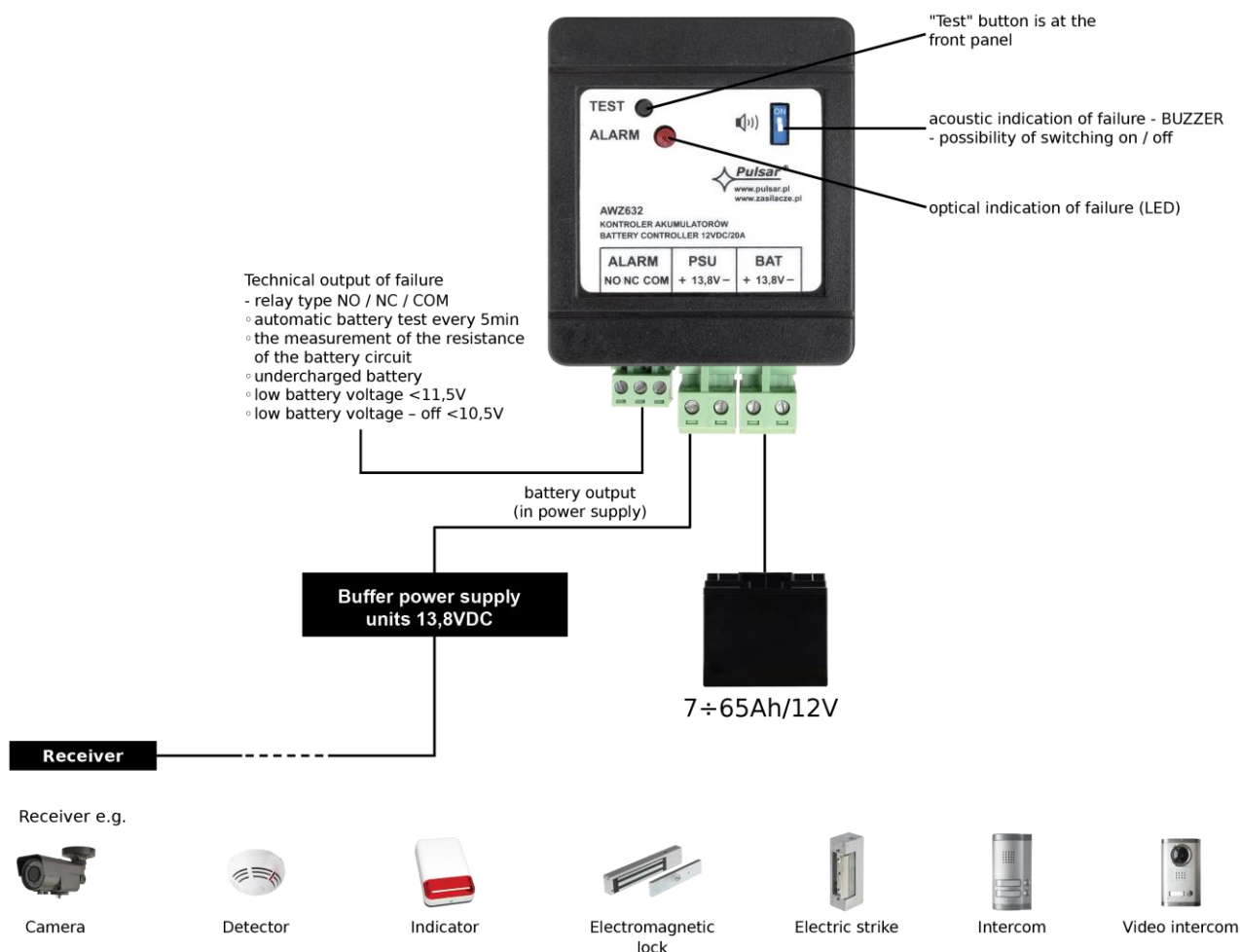

### TABLE OF CONTENTS:

#### 1. Technical description.

##### 1.1. General description

##### 1.2. Block diagram

##### 1.3. Description of elements and connectors of the controller

##### 1.4. Technical parameters

#### 2. Mounting.

##### 2.1. Requirements

##### 2.2. Installation procedure

#### 3. Indication of operation of the battery controller.

##### 3.1. Optical indication

##### 3.2. Technical output

##### 3.3. Acoustic indication

#### 4. Maintenance and operation.

##### 4.1. Automatic battery test

##### 4.2. Short circuit of the controller output/reverse connection

##### 4.3. Maintenance.

**1. Technical description.**

**1.1. General description.**

**AWZ632** battery controller is designed for monitoring the status of the (Capacity: 7 ÷ 65 Ah / 12 V (SLA)) battery pack based on the measurements of resistance, continuity of the battery circuit, voltage and the charge level. It is also protected against reverse connection and short circuit in the charging circuit. In the case of failure, a LED light is activated, which is accompanied by switching of relay contacts and acoustic indication.

**1.2. Block diagram.**

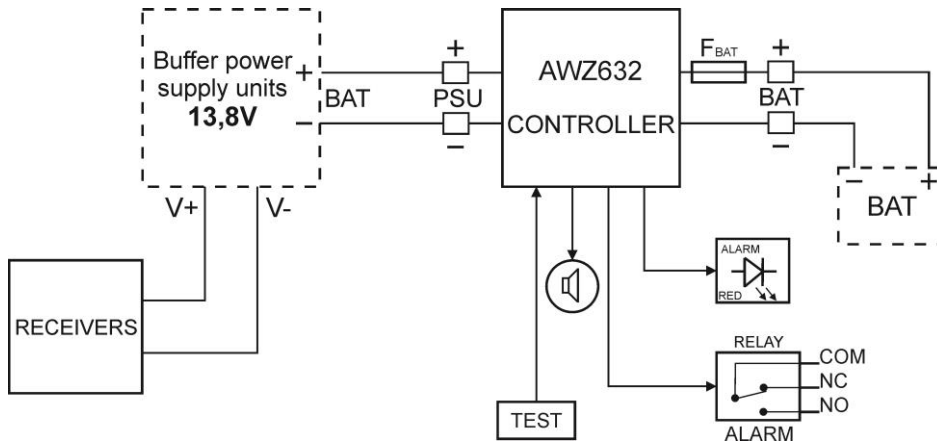



Fig.1. The block diagram of the controller.

**1.3. Description of elements and connectors of the controller**

**Table 1. Elements of the front panel of the controller.**

Component No. [Fig. 2]	Description
①	<b>TEST</b> – test button
②	<b>LED ALARM</b> – red LED indicating failure
③	<b>BUZZER, micro switch</b> , enable/disable the acoustic indication  Switch in the upper position, the indication is ON  Switch in the lower position, acoustic indication is OFF
④	<b>ALARM</b> – technical output of collective failure - relay type
⑤	<b>PSU</b> – connector of the charging circuit
⑥	<b>BAT</b> – connector of the battery

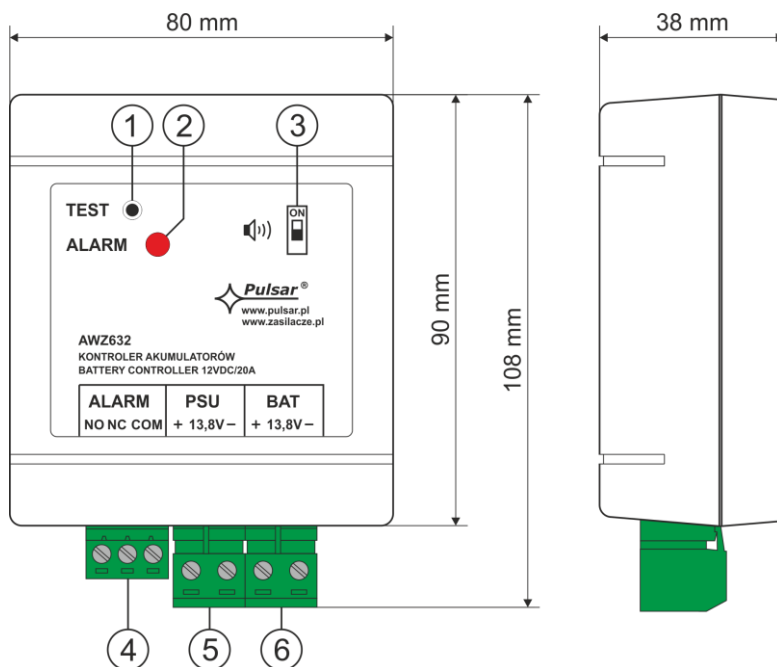

Fig. 2. General view.

#### 1.4. Technical parameters.

- Electrical parameters (Table 2)
- Mechanical parameters (Table 3)
- Operation safety (Table 4)
- Operation parameters (Table 5)

#### Electrical parameters (Table 2).

Fitting battery	7 ÷ 65 Ah / 12 V (SLA)
The BAT output current	20 A max.
The BAT output voltage	13,8 V DC max.
Battery output protection against short-circuit and reverse polarity connection	(19 mm) – 25 A time delay fuse
Optical indication of operation	ALARM LED
Acoustic indication of operation	Piezoelectric indicator ~75 dB / 0,3 m
ALARM – technical output of collective failure indication	Relay type: 1 A @ 30 V DC / 48 V AC

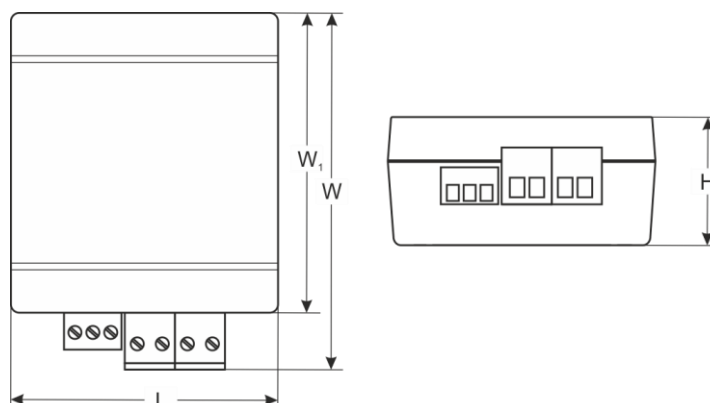

#### Mechanical parameters (Table 3).

Dimensions	W=108, W <sub>1</sub> =90, H=38, L=80 [+/- 2mm]
Net/gross weight	0,15 / 0,18 [kg]
Enclosure	ABS, color RAL 9005, black
Connectors	PSU inputs: $\Phi 0,5 \div 3,2$ (AWG 24-8) 0,5-4mm <sup>2</sup> BAT output: $\Phi 0,5 \div 3,2$ (AWG 24-8) 0,5-4mm <sup>2</sup> ALARM output: $\Phi 0,5-2,1$ (AWG 24-12) 0,5-1,5mm <sup>2</sup>

**Operation parameters (Table 4)**

Operation temperature	-10°C...+40°C
Storage temperature	-20°C...+60°C
Relative humidity	20%...90%, no condensation
Sinusoidal vibrations during operation:	Unacceptable
Surges during operation	Unacceptable
Direct insolation	Unacceptable
Vibrations and surges during transport	According to the PN-83/T-42106 standard

**2. Mounting.**

**2.1. Requirements.**

The enclosure should be mounted by a qualified installer, holding relevant (applicable and required for a given country) permits and licenses for low-voltage installations. Unit should be mounted in confined spaces with normal relative humidity (RH=90% maximum, without condensing) and temperature from -10°C to +40°C. In order to meet the requirements of LVD and EMC directives, the rules for power supply, enclosures, shielding, and cable routing, depending on application, must be observed.

**2.2. Installation procedure.**

1. Connect the battery to the BAT socket of the controller, paying attention to polarity.
2. Place the batteries e.g. at the bottom of the RACK cabinet, ensuring adequate ventilation.
3. Connect the battery controller to the uninterruptible power supply with the appropriate battery and charging circuit protection.
4. Close the enclosure, cabinet, etc. once the tests and operation control are completed.

**3. Indication of operation of the battery controller.**

**3.1. Optical indication.**

The controller is equipped with LED light at the front panel:



RED LED:

- ON/blinking – Indicates a failure (Table 6)
- OFF – No errors/normal operation

**3.2. Technical output.**

The controller is fitted with the **ALARM** technical output of collective failure. The collective failure can be triggered by the events presented in Table 6.

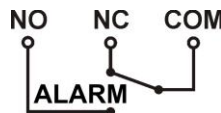

Fig. 6. The electrical diagram of the ALARM output of collective failure.



**CAUTION!** In Fig. 6 the set of contacts shows a potential-free status of the relay which corresponds to a failure.

**3.3. Acoustic indication.**

The failure status is also signaled acoustically by means of a piezoelectric indicator (in accordance with Table 6). Acoustic indication can be disabled with an ON/OFF switch \*)).



Switch in the upper position, the indication is ON



Switch in the lower position, acoustic indication is OFF

**Table 6. Table of errors**

State, failure	Optical indication	Acoustic indication	Technical output	Causes, comments
The start of the test	Absence	2 short beeps	INACTIVE	- Start of the battery test
High resistance of the BAT circuit	Blinks	1 beep every 10 seconds	ACTIVE	- Batteries worn out - Loose connectors
Undercharged battery	Blinks	1 beep every 10 seconds	ACTIVE	- Undercharged battery
No battery	Blinks	1 beep every 10 seconds	ACTIVE	- Blown F <sub>BAT</sub> fuse - No battery
Low battery voltage (DC operation)	Lit	2 short beeps every 10 seconds	ACTIVE	- The batteries voltage has dropped below 11,5 V during battery (assisted operation)
Low battery voltage - disconnection (DC operation)	Absence	2 beeps every 10 seconds (without repeat)	ACTIVE	- The batteries voltage has dropped below 10,5 V during battery (assisted operation)

#### 4. Maintenance and operation.

##### 4.1. Automatic battery test

The battery controller performs a battery test every 5 minutes, temporarily stopping the charge process, while measuring voltage at the battery terminals and the resistance of the battery circuit. The test can also be started manually by pressing the "TEST" button on the front panel, but not more often than once every 1 minute. The activation or deactivation of the test will be confirmed acoustically (see Table 6).

##### 4.2. Short circuit of the controller output/reverse connection.

The BAT controller output is additionally protected against short circuit by a fuse (box); in the case of damage, it should be replaced with a fuse of the same type. The fuse is located inside the unit.

##### 4.3. Maintenance.

The battery controller does not require any specific maintenance; however, it should be cleaned with compressed air if used in dusty conditions.



##### WEEE LABEL

**Waste electrical and electronic equipment must not be disposed of with normal household waste. According to the European Union WEEE Directive, waste electrical and electronic equipment should be disposed of separately from normal household waste.**

*Controller is adapted for lead-acid battery (SLA). After operation period they must not be thrown but recycled according to applicable law.*

##### **Pulsar sp. j.**

Siedlec 150, 32-744 Łapczyca, Poland  
 Tel. (+48) 14-610-19-40, Fax. (+48) 14-610-19-50  
 e-mail: [biuro@pulsar.pl](mailto:biuro@pulsar.pl), [sales@pulsar.pl](mailto:sales@pulsar.pl)  
 http:// [www.pulsar.pl](http://www.pulsar.pl), [www.zasilacze.pl](http://www.zasilacze.pl)