

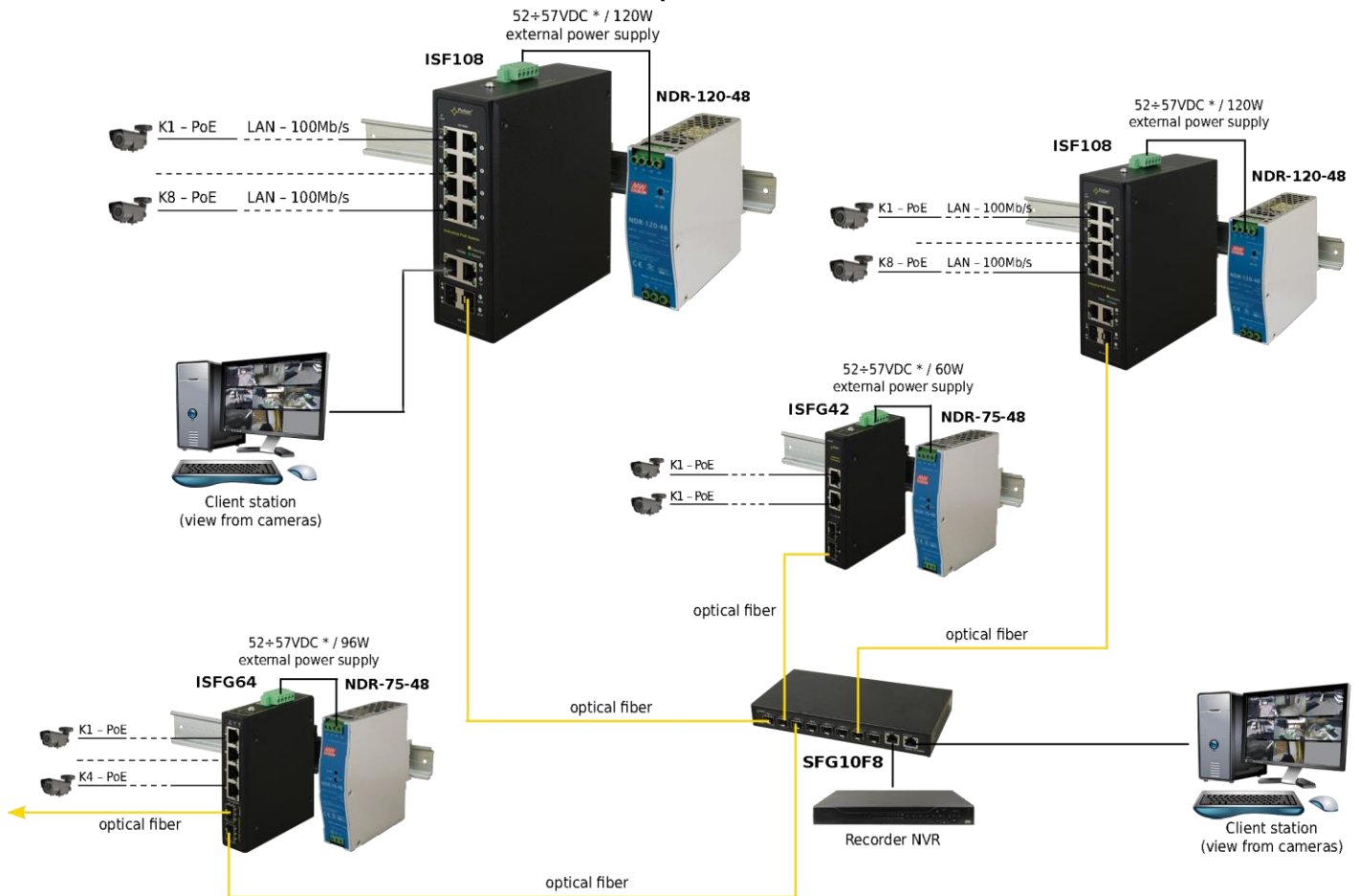

Features:

- 12 ports switch
8 PoE ports 10/100 Mb/s, (1÷8 ports) (data and power supply)
2 ports 10/100/1000 Mb/s (TP/9, TP/10 ports) (UpLink)
2 ports 1000 Mb/s SFP (SFP/11, SFP/12 ports) (UpLink)
- 30 W for each PoE port, supports devices compliant with IEEE802.3af/at standard
- Supports auto-learning and auto-aging of MAC addresses (16K size)
- **Possibility of redundant power supply**
- Mounting on a DIN rail (TH35)
- LED indication
- warranty – 5 year

Example of use.



1. Technical description

1.1. General description.

ISF108 is a 12-ports PoE switch designed to supply IP cameras operating in IEEE 802.3af/at standard. Automatic detection of any devices powered in the PoE standard is enabled at the 1 – 8 ports of the switch. The TP/9 and TP/10 ports is used for connection of another network device via RJ45 connector. The switch is fitted with SFP slots (marked as SFP/11 and SFP/12), the use of fiber optic module (GBIC) allows fiber optic transmission. Device has solutions that allow it to be powered from two sources (emergency power supply, redundant power supply) – in case of a failure of one source, it immediately switches to backup one.

LEDs at the front panel indicate the operation status (description in the table 3). PoE technology ensures a network connection and reduces installation costs by eliminating the need to supply a separate power cable for each device. This method allows supplying other network devices, such as IP phone, wireless access point or router.

1.2 Block diagram.

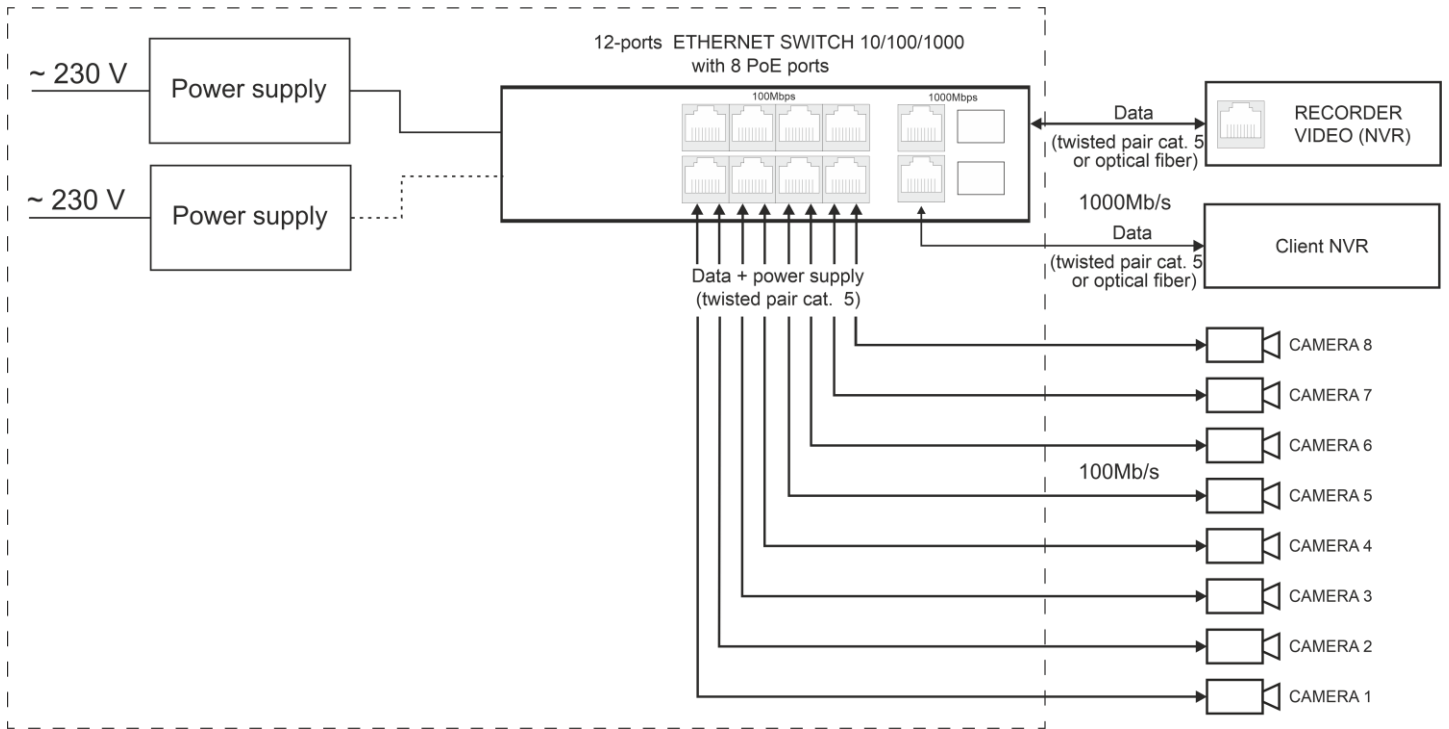

Fig. 1. Block diagram.

1.3 Description of components and connectors.

Table 1. (See Fig. 2)

Component No. (Fig. 2)	Description
[1]	8 x PoE ports (1÷8)
[2]	2 x UPLINK ports (TP/9, TP/10)
[3]	2 x UPLINK ports (SFP/11, SFP/12)
[4]	Power Socket (V1/V2)
[5]	Holder for DIN rail

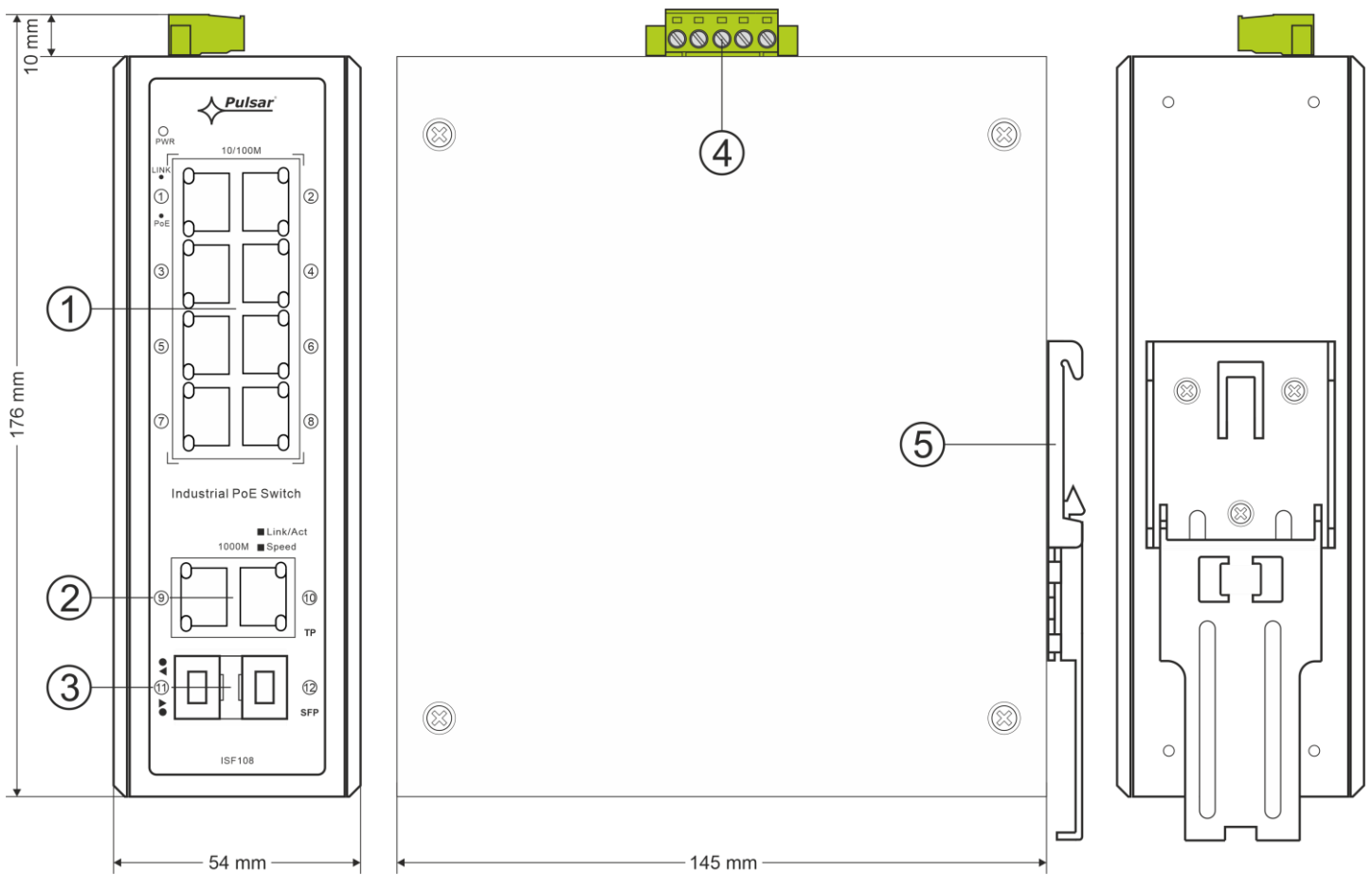

Fig. 2. The view of the switch.

1.4 Technical parameters

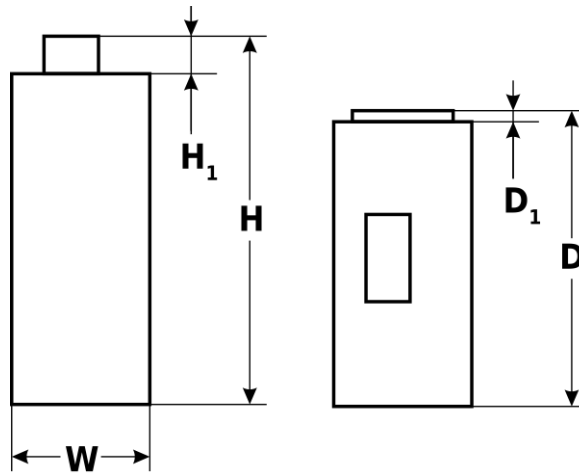

Table 2.

Ports	8 x PoE (10/100 Mb/s) (RJ-45) 2 x UPLINK (10/100/1000 Mb/s) (RJ-45) 2 x UPLINK (1000 Mb/s) (SFP) with connection speed auto-negotiation and MDI/MDIX Auto Cross
PoE power supply	IEEE 802.3af/at (1+8 ports), 52 V DC / 30 W at each port *
Protocols, Standards	IEEE802.3, 802.3u, 802.3x CSMA/CD, TCP/IP
Bandwidth	5,6 Gb/s
Transmission method	Store-and-Forward
Optical indication of operation	Switch power supply; Link/Act; PoE Status
Power supply	Switch: 12-57 V DC; 2,3 A max. PoE: 48-57 V DC; 2,3 A max.
Self-power consumption	5 W max.
Operating conditions	Temperature -30°C ÷ +70°C, Relative humidity 5% - 90%, no condensation

Dimensions	W=54, H=176, H ₁ =10, D=153, D ₁ =8 [+/- 2 mm]
Gross/Net weight	0,9 / 1,1 [kg]
Protection class EN 62368-1	I (first)
Storage temperature	-30°C ÷ +70°C
Declarations	CE

* The given value of 30 W per port is the maximum value. The total power consumption should not exceed 120 W.

2. Installation

2.1. Requirements

Unit should be mounted in confined spaces with normal relative humidity (RH=90% maximum, without condensing) and temperature from -30°C to +70°C. Ensure the free flow of air around the unit. The PSU shall work in a vertical position that guarantees sufficient convectional air-flow through ventilating holes of the enclosure.

The switch load balance should be done before installation. Depending on application, appropriate power supply should be selected, PoE available only at 48-57 V (52 V recommended). The given value of 30 W per port is the maximum value referring to a single output. The total power consumption should not exceed 120 W. The increased demand for power is particularly evident in the case of cameras with heaters or infrared illuminators - when launching these features, the power consumption increases rapidly, which may adversely affect the operation of the switch. As the device is designed for a continuous operation and is not equipped with a power-switch, therefore an appropriate overload protection in the power supply circuit should be provided. The electrical system shall be made in accordance with applicable standards and regulations.

2.2. Installation procedure

1. Connect switch to power supply unit(s), paying attention to polarization and other parameters.
2. Connect the power supply(s) to the 230 V socket.
3. Connect the camera wires to the RJ45 connectors (sockets RJ45 from 1 to 8).
4. Connect the remaining LAN devices to RJ45 (TP/9 and TP/10) and socket SFP (SFP/11 and SFP/12).
5. Check the optical indication of switch operation (see Table 3).

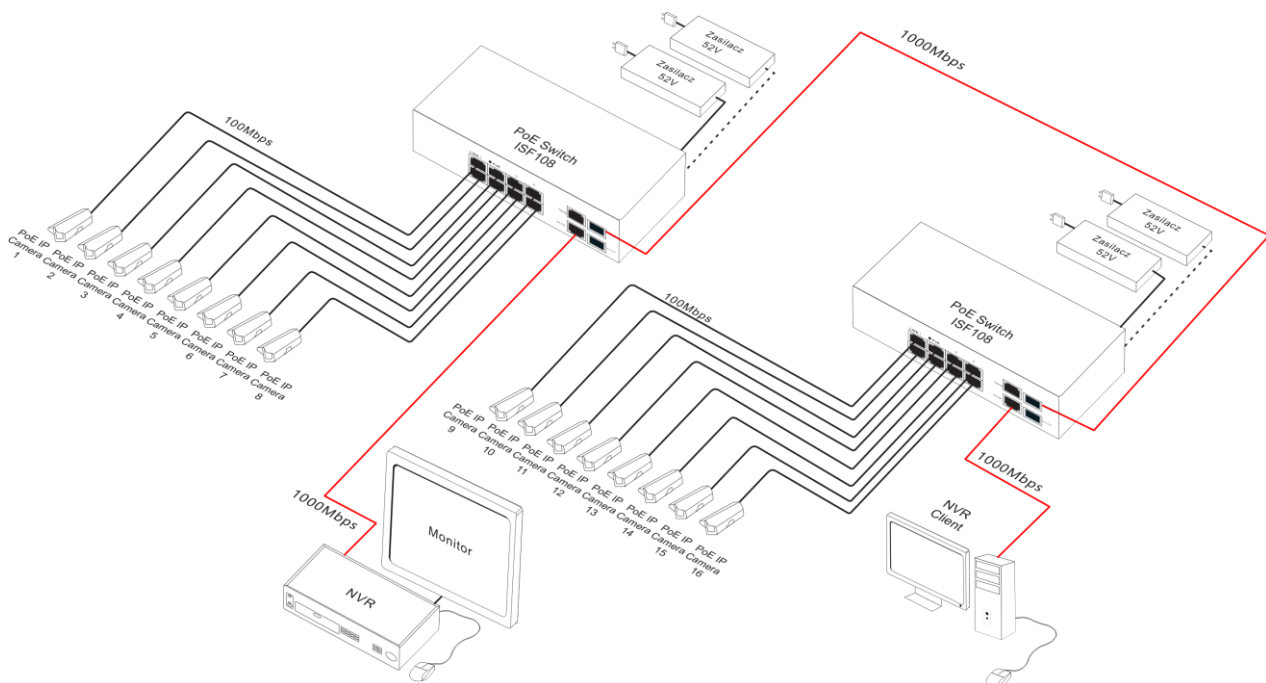

Connection schemes:





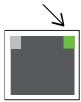

3. Operation indication (see Table 3).

Table 3. Operation indication

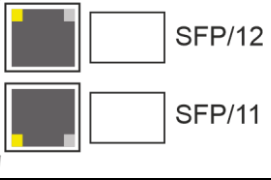
OPTICAL INDICATION OF THE SWITCH'S POWER SUPPLY	
GREEN LED LIGHT (Power) Indication of the switch's power supply	PWR  OFF – no power supply of the switch ON – power supply on, normal operation

OPTICAL INDICATION AT THE PoE PORTS (1÷8)	
GREEN LED LIGHT (PoE) Indication of the PoE power supply at the RJ45 ports	 OFF – no power supply at the RJ45 port (the device is not connected or not compliant with IEEE802.3af/at standard) ON – power supply Blinking – short-circuit or output overload
YELLOW LED LIGHT (LINK) The connection status of LAN devices 10/100 Mb/s and data transmission	 OFF – no connection ON – device is connected 10/100 Mb/s Blinking – data transmission

OPTICAL INDICATION AT THE UP LINK PORTS (TP/9, TP/10)	
YELLOW LED LIGHT (SPEED)	 OFF – connection 10 Mb/s 11 and 100 Mb/s ON – connection 1000 Mb/s
GREEN LED LIGHT (LINK)	 OFF – no connection ON – device is connected Blinking – data transmission

OPTICAL INDICATION AT THE UP LINK PORTS (SFP/11, SFP/12)	
GREEN LED LIGHT (SFP/11)	 OFF – no connection ON – device is connected Blinking – data transmission
GREEN LED LIGHT (SFP/12)	 OFF – no connection ON – device is connected Blinking – data transmission

	WEEE LABEL Waste electrical and electronic equipment must not be disposed of with normal household waste. According to the European Union WEEE Directive, waste electrical and electronic equipment should be disposed of separately from normal household waste.
---	--

Pulsar sp. j. Siedlec 150, 32-744 Łapczyca, Poland Tel. (+48) 14-610-19-45 e-mail: sales@pulsar.pl http:// www.pulsar.pl			
			