

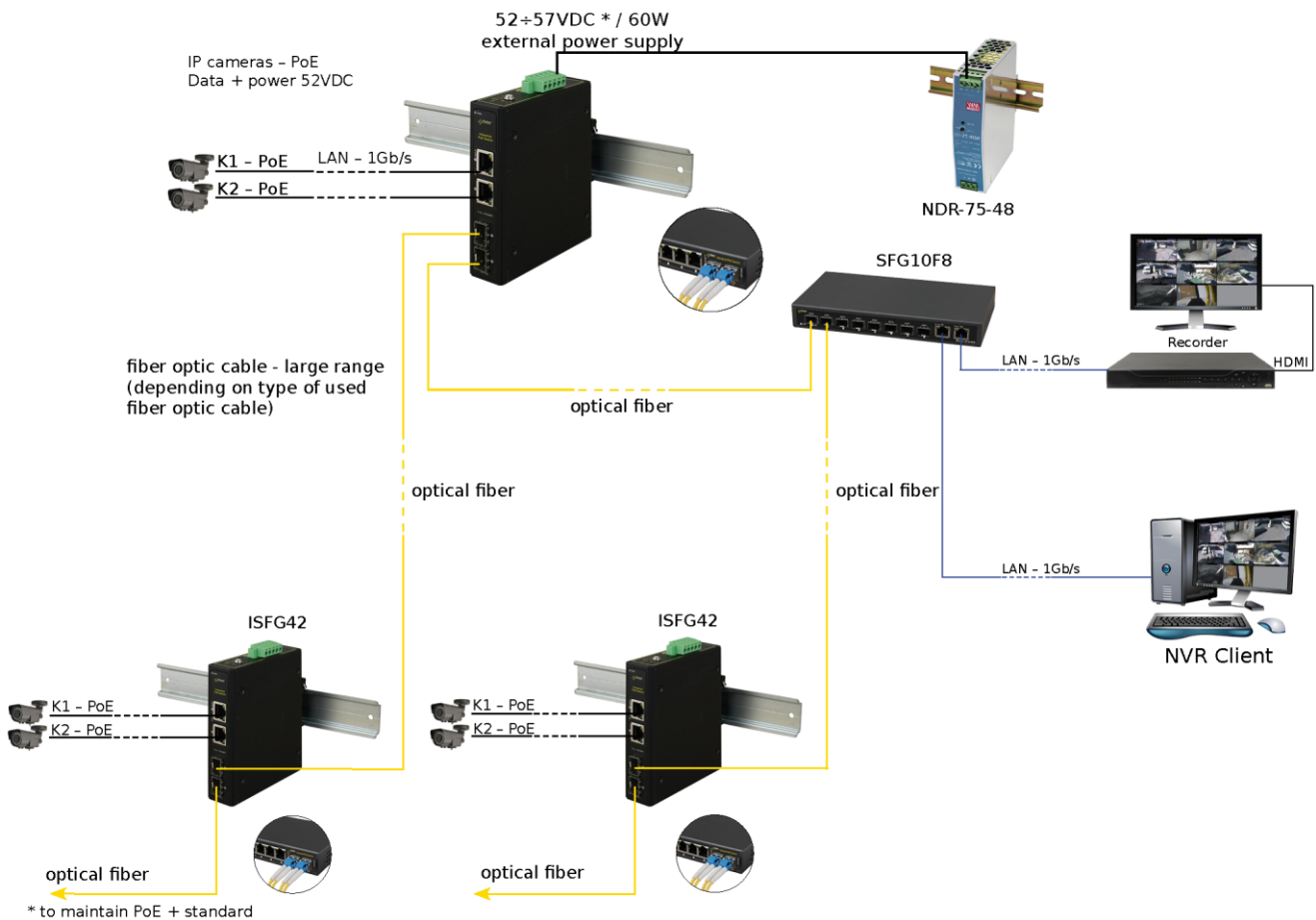

### Features:

- 4 ports industrial switch
- 2 PoE ports 10/100/1000 Mb/s, (1+2 ports) (data and power supply)
- 2 ports 1000 Mb/s SFP
- 30 W for each PoE port, supports devices compliant with IEEE802.3af/at (**PoE+**) standard
- Supports auto-learning and auto-aging of MAC addresses (8K size)
- **Possibility of redundant power supply**
- Mounting on a DIN rail (TH35)
- LED indication
- warranty – 5 year

### Example of use



## 1. Technical description

### 1.1. General description.

ISFG42 is a 4-ports PoE switch designed to supply IP cameras operating in IEEE 802.3af/at standard. Automatic detection of any devices powered in the PoE/PoE+ standard is enabled at the 1 – 2 ports of the switch. UP LINK ports (marked 3 and 4) are used to connect further network devices using fiber optics (using SFP modules - GBIC). On front panel there is LEDs signaling of the device's status (description in table below). Device has solutions that allow it to be powered from two sources (emergency power supply, redundant power supply) – in case of a failure of one source, it immediately switches to backup one.

The PoE technology ensures a network connection and reduces installation costs by eliminating the need to supply a separate power cable for each device. This method allows supplying other network devices, such as IP phone, wireless access point or router.

## 1.2 Block diagram.

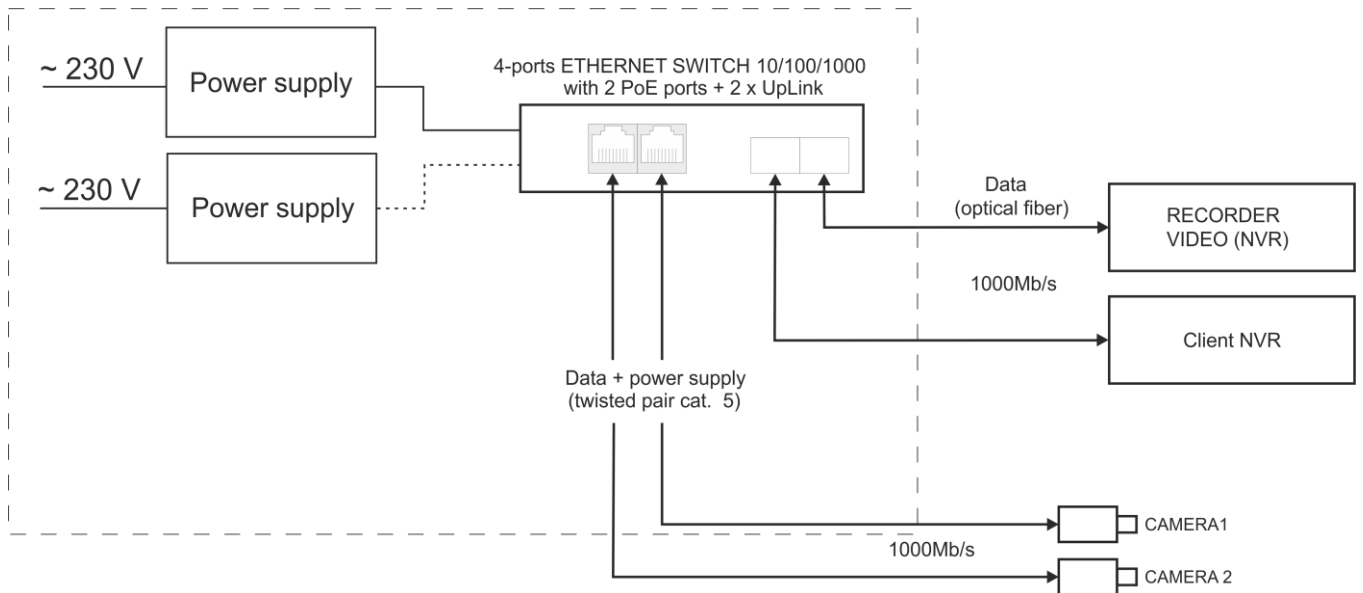

Fig. 1. Block diagram.

## 1.3 Description of components and connectors.

Table 1. (See Fig. 2)

Component No. (Fig. 2)	Description
[1]	2 x PoE ports (1÷4)
[2]	2 x UP LINK ports (SFP)
[3]	Power Socket (V1/V2)
[4]	Holder for DIN rail

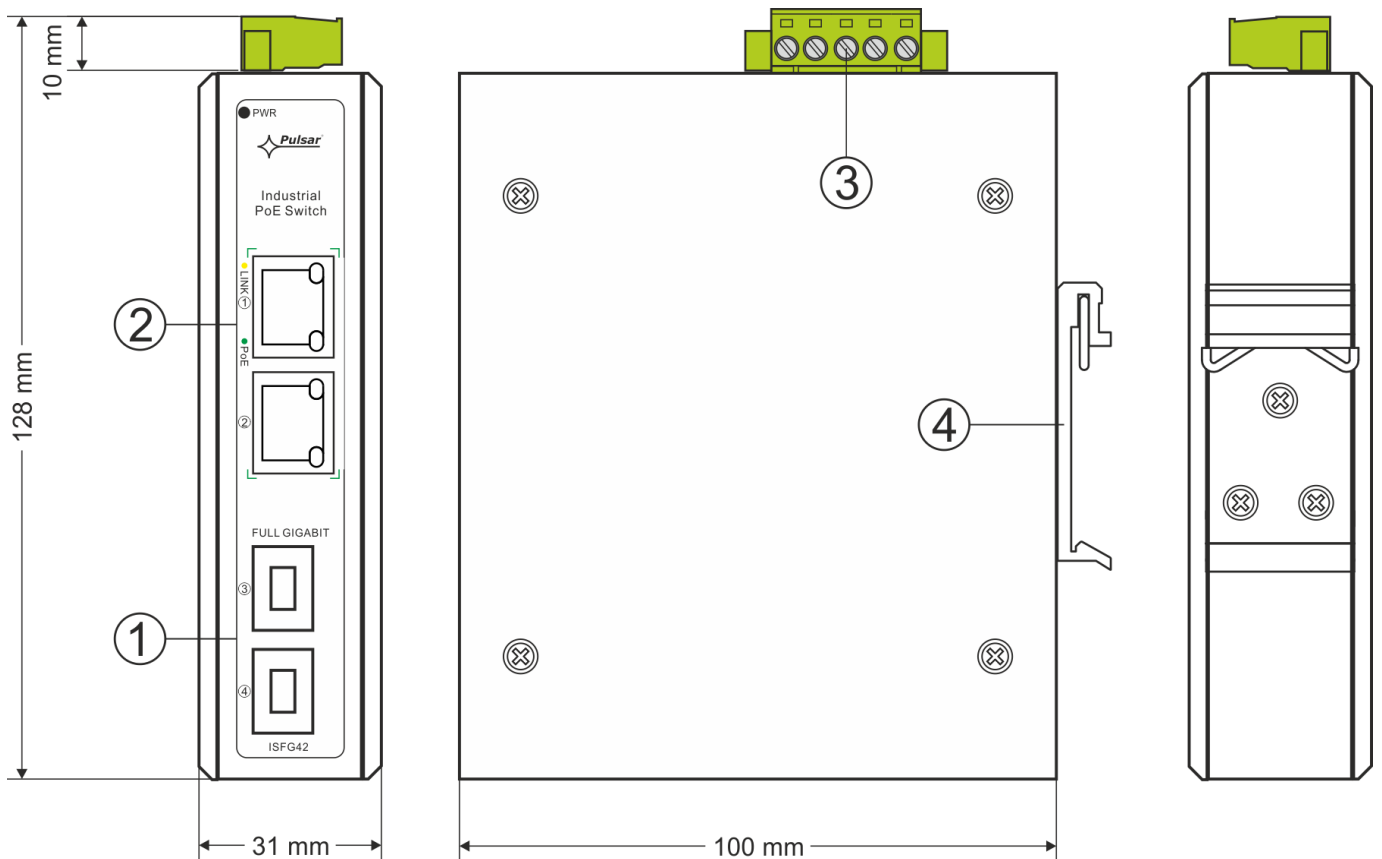

Fig. 2. The view of the switch.

## 1.4 Technical parameters

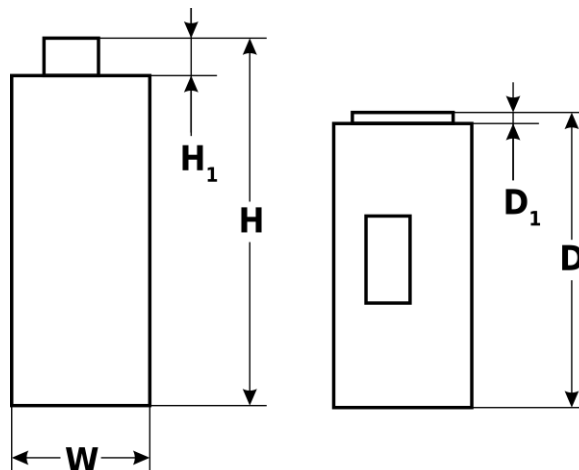

Table 2.

<b>Ports</b>	2 ports 10/100/1000 Mb/s (PoE) 2 ports 1000 Mb/s (UP LINK) with connection speed auto-negotiation and MDI/MDIX Auto Cross)
<b>PoE power supply</b>	IEEE 802.3af/at (1÷2 ports), 52 V DC / 30 W at each port *
<b>Protocols, Standards</b>	IEEE802.3, 802.3u, 802.3x CSMA/CD, TCP/IP
<b>Bandwidth</b>	12 Gb/s
<b>Transmission method</b>	Store-and-Forward
<b>Optical indication of operation</b>	Switch power supply; Link/Act; PoE Status
<b>Power supply</b>	Switch: 12-57 V DC; 1,2 A max. PoE: 48-57 V DC; 1,2 A max.
<b>Self-power consumption</b>	5 W max.
<b>Operating conditions</b>	Temperature -30°C ÷ +70°C, Relative humidity 5% - 90%, no condensation
<b>Dimensions</b>	W=30, H=128, H <sub>1</sub> =10, D=112, D <sub>1</sub> =8 [+/- 2 mm]
<b>Gross/Net weight</b>	0,3 / 0,4 [kg]
<b>Protection class EN 62368-1</b>	I (first)
<b>Storage temperature</b>	-30°C ÷ +70°C
<b>Declarations</b>	CE

\* The given value of 30 W per port is the maximum value. The total power consumption should not exceed 60 W.

## 2. Installation

### 2.1. Requirements

Unit should be mounted in confined spaces with normal relative humidity (RH=90% maximum, without condensing) and temperature from -30°C to +70°C. Ensure the free flow of air around the unit. The PSU shall work in a vertical position that guarantees sufficient convectional air-flow through ventilating holes of the enclosure.

The switch load balance should be done before installation. Depending on application, appropriate power supply should be selected, PoE available only at 48-57 V (52 V recommended). The given value of 30 W per port is the maximum value referring to a single output. The total power consumption should not exceed 60 W. The increased demand for power is particularly evident in the case of cameras with heaters or infrared illuminators - when launching these features, the power consumption increases rapidly, which may adversely affect the operation of the switch. As the device is designed for a continuous operation and is not equipped with a power-switch, therefore an appropriate overload protection in the power supply circuit should be provided. The electrical system shall be made in accordance with applicable standards and regulations.

### 2.2. Installation procedure

1. Connect switch to power supply unit(s), paying attention to polarization and other parameters.
2. Connect the power supply(s) to the 230 V socket.
3. Connect the camera wires to the RJ45 connectors (sockets RJ45).
4. Check the optical indication of switch operation (see Table 3).

Connection schemes:

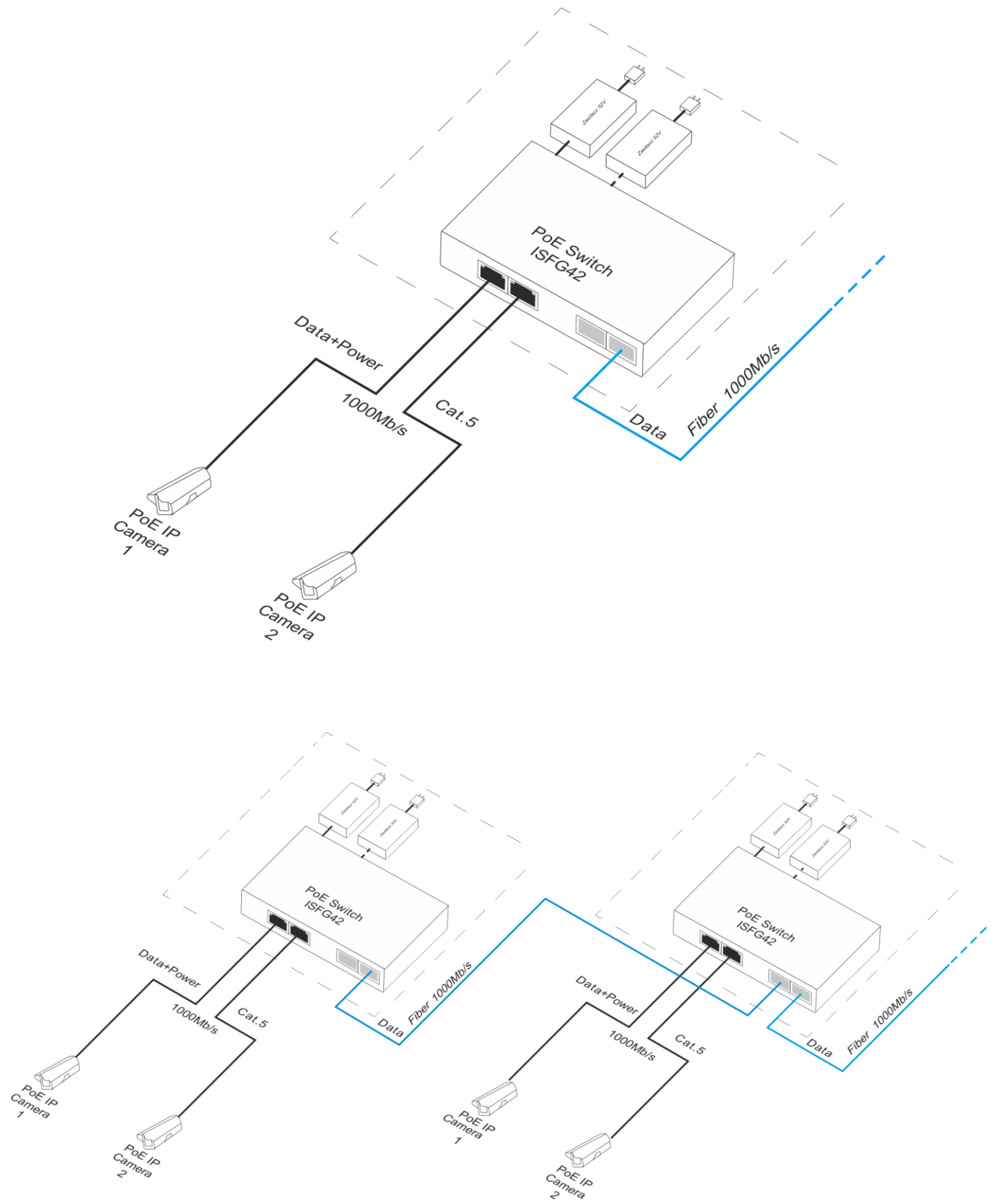



### 3. Operation indication.

Table 3. Operation indication



#### OPTICAL INDICATION OF THE SWITCH'S POWER SUPPLY

<b>GREEN LED LIGHT (Power)</b> Indication of the switch's power supply	<b>PWR</b> 	<b>OFF</b> – no power supply of the switch <b>ON</b> – power supply on, normal operation
---	--	---

#### OPTICAL INDICATION AT THE PoE PORTS (1÷2)

<b>GREEN LED LIGHT (PoE)</b> Indication of the PoE power supply at the RJ45 ports		<b>OFF</b> – no power supply at the RJ45 port (the device is not connected or not compliant with IEEE802.3af/at standard) <b>ON</b> – power supply at the RJ45 port <b>Blinking</b> – short-circuit or output overload
<b>YELLOW LED LIGHT (LINK)</b> The connection status of LAN devices 10/100 Mb/s and data transmission		<b>OFF</b> – no connection <b>ON</b> – the device is connected 10/100Mb/s <b>Blinking</b> – data transmission

#### OPTICAL INDICATION AT THE UP LINK PORTS

<b>GREEN LED LIGHT (3)</b> The connection status of LAN devices and data transmission		<b>OFF</b> – device no connection <b>ON</b> – device is connected <b>Blinking</b> – data transmission
<b>GREEN LED LIGHT (4)</b> The connection status of LAN devices and data transmission		<b>OFF</b> – device no connection <b>ON</b> – device is connected <b>Blinking</b> – data transmission



**WEEE LABEL**

**Waste electrical and electronic equipment must not be disposed of with normal household waste. According to the European Union WEEE Directive, waste electrical and electronic equipment should be disposed of separately from normal household waste.**

**Pulsar sp. j.**  
 Siedlec 150, 32-744 Łapczyca, Poland  
 Tel. (+48) 14-610-19-45  
 e-mail: [sales@pulsar.pl](mailto:sales@pulsar.pl)  
 http:// [www.pulsar.pl](http://www.pulsar.pl)

