



# **PSACH 01244**

v.1.2

## **PSACH 24VAC/4A/1x4A AC power supply for 1 rotating camera, ABS enclosure**

EN

Edition: 9 from 29.07.2022

Supersedes edition: 8 from 02.11.2017



**Features:**

- ~24 V / 4 A or ~27 V / 3,7 A power output for powering camera
- power voltage ~ 230 V
- protections:
  - SCP short-circuit protection
  - OLP overload protection
  - OHP overheat protection
  - against tampering
- IP65 ABS, hermetic enclosure
- warranty – 2 years from production date

Sample power supply unit for rotating camera supplied with AC voltage.

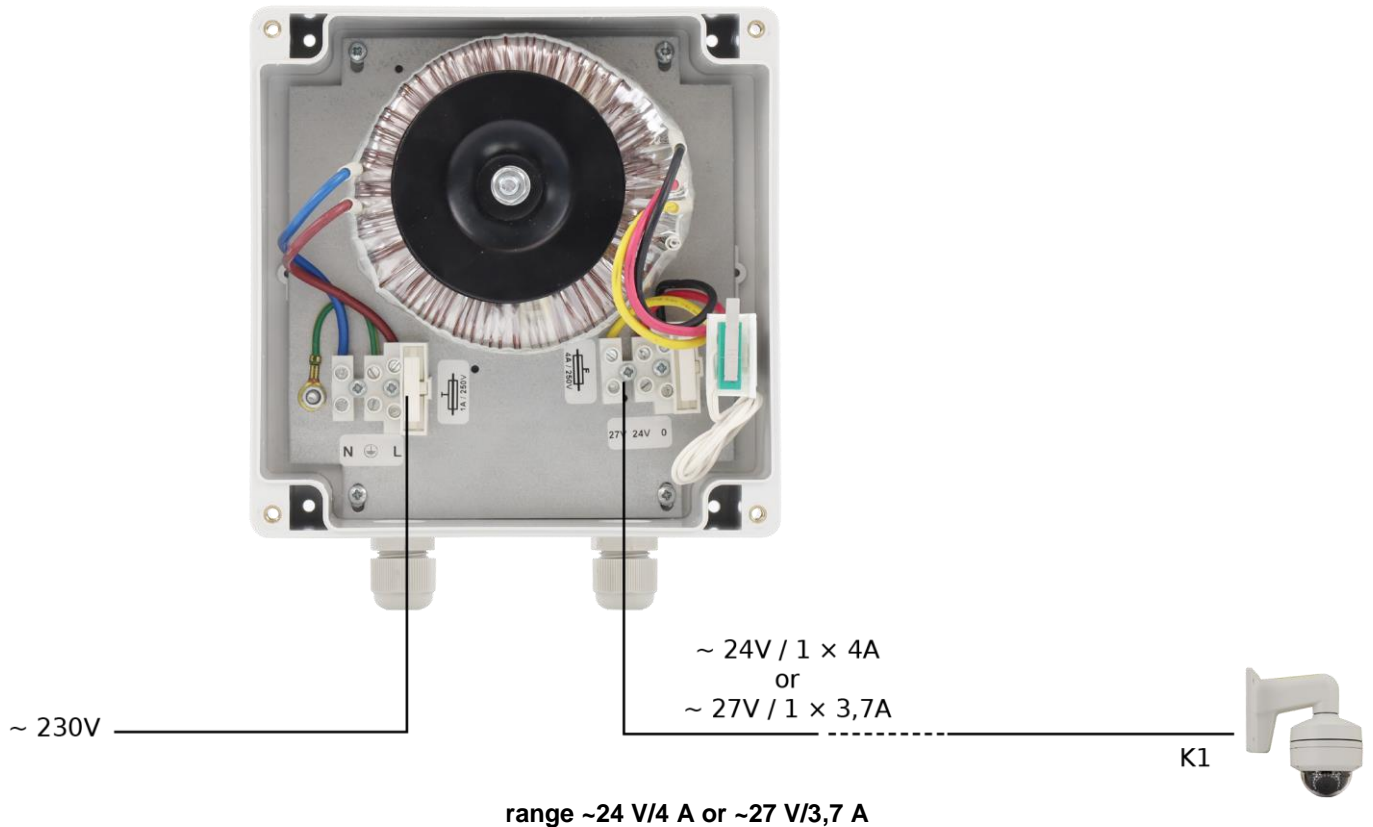

Schematic diagram of a power supply:

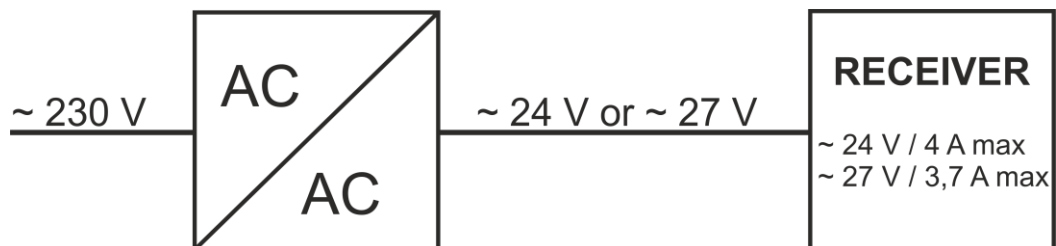
**CONTENTS:**

1. Technical description.
  - 1.1 General description
  - 1.2 Block diagram
  - 1.3 Description of PSU components
  - 1.4 Specifications
2. Installation.
  - 2.1 Requirements
  - 2.2 Installation procedure
3. Operating status indication.
  - 3.1 Technical output
4. Operation and use.
  - 4.1. Overload or short circuit at the PSU output
  - 4.2. Maintenance

**1. Technical description.**

**1.1. General description.**

AC/AC PSU intended for supplying devices requiring voltage AC of **~24 V** (U1= ~24 V / U2= ~27 V) and total capacity of **4 A@~24 V**. It features protections: short-circuit (SCP), overload (OLP), transformer overheating (OHP). PSU is housed in a ABS enclosure that features a microswitch indicating unwanted opening of the front door (faceplate).

**1.2. Block diagram.**

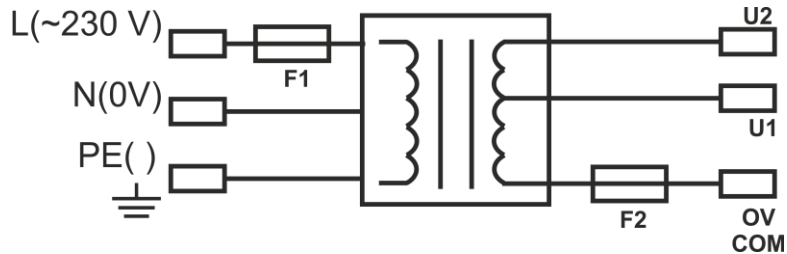

Fig.1. Block diagram of the PSU.

**1.3. Description of PSU components.**

**Tab.1. Elements of the power supply unit.**

Element no. [Fig. 2]	Description
[1]	Isolation transformer
[2]	TAMPER, tampering connector (NC)
[3]	AUX: U2-U1-0V secondary voltage connector, devices power supply (SEC)
[4]	F2 fuse in the secondary voltage circuit
[5]	F1 fuse in the power supply circuit (~230 V, PRI)
[6]	L-N connector ~230 V, PE protection connector

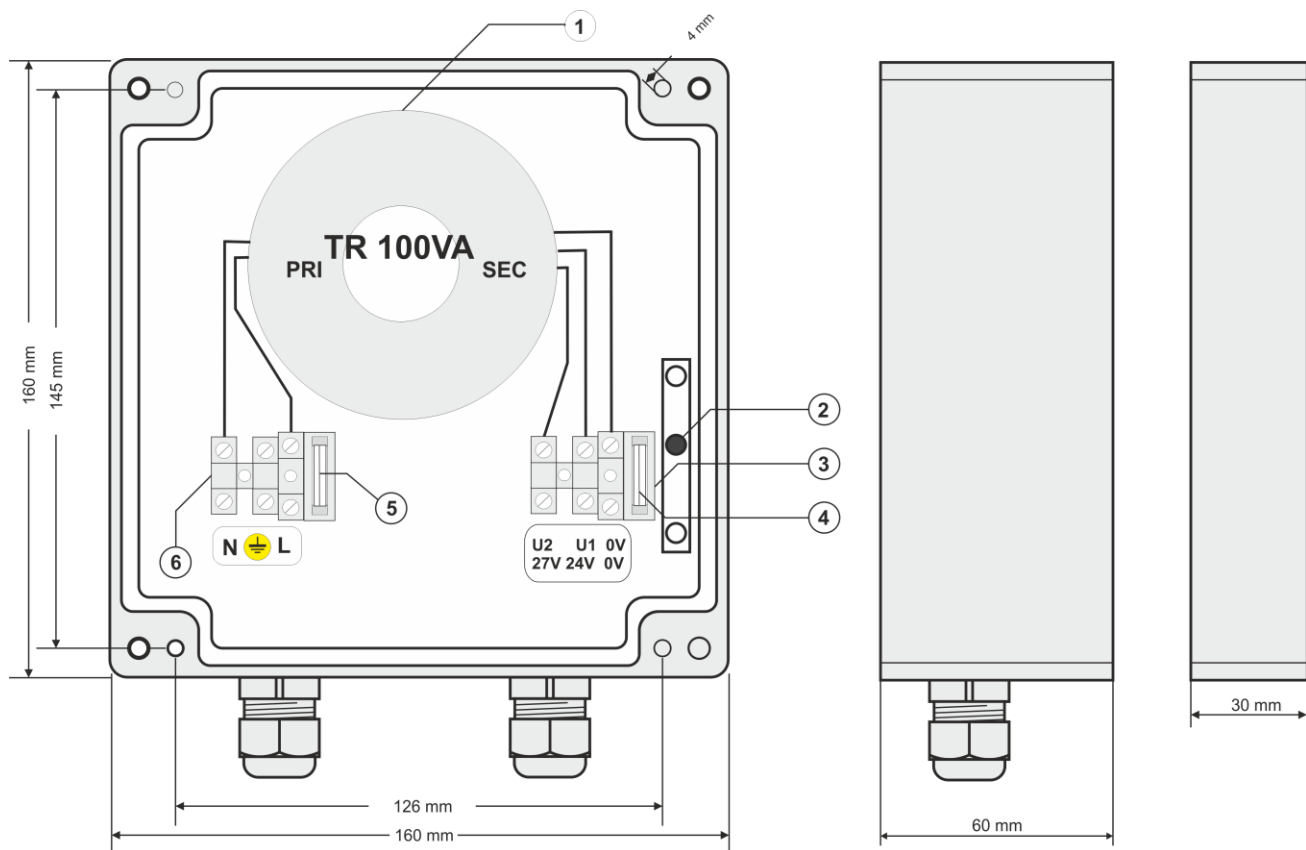
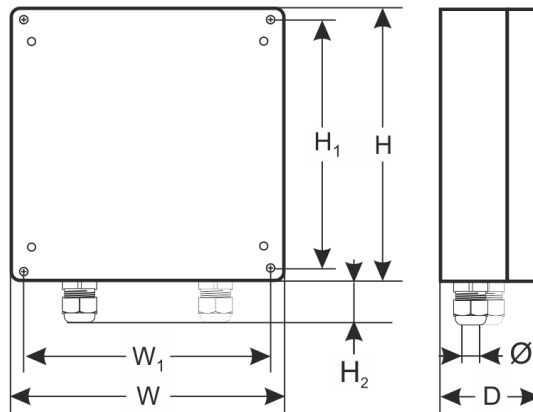

Fig.2. The view of the PSU.



#### 1.4 Specifications:

- electrical specifications (tab. 2)
- mechanical specifications (tab. 3)
- operation safety (tab. 4)
- operating specifications (tab. 5)

#### Electrical specifications (tab. 2).

Supply voltage	~ 230 V
Current consumption	0,5 A
Power frequency	50 Hz
Power of S PSU	100 VA max.
Output voltage	U1: ~23 – 28 V (100% load ÷ 0% load) U2: ~25,5 - 31,5 V (100% load ÷ 0% load)
Output current	4 A@~24 V max. or 3,7 A@~27 V max.
Short-circuit protection SCP	1x F 4A glass fuse - glass fuse damage requires fuse-element replacement
Overload protection OLP	circuit 24 V: 1x F 4A circuit 230 V: 1x T 1A
Overheat protection OHP	inside transformer
Sabotage protection: - TAMPER output indicating enclosure opening	- microswitch, NC contacts (enclosure closed), 0,5 A@ 50 V DC (max.)
F1 fuse	T 1A/ 250V
F2 fuse	F 4A/ 250V

#### Mechanical specifications (tab. 3).

External dimensions of the PSU	W=160, H=160, D=90 [+/- 2 mm]
Mounting dimensions PSU	W <sub>1</sub> =126, H <sub>1</sub> =145 [+/- 2 mm]
Height glands	H <sub>2</sub> =25 [mm]
Number of cable glands/ Ø cables	2szt. / 4 ÷ 8mm
Net/gross weight	2,2 / 2,3 [kg]
Enclosure	ABS, IP65, light grey
Closing	Cheese head screw x 4 (at front)
Connectors	Power supply: Ø0,63 ÷ 2,50 (AWG 22-10) Outputs: Ø0,63 ÷ 2,50 (AWG 22-10), TAMPER output: wires, 25cm
Notes	Enclosure has a removable mounting board with PSU systems.

#### Operation safety (tab.4).

Protection class EN 62368-1	I (first)
Protection grade EN 60529	IP65
Electrical strength of insulation: - between input and output circuits of PSU - between input circuit and protection circuit - between output circuit and protection circuit	4000 V DC min. 2500 V DC min. 500 V DC min.
Insulation resistance: - between input circuit and output or protection circuit	100 MΩ, 500 V DC

**Operating specifications (tab.5).**

Operating temperature	-25°C...+40°C
Storage temperature	-25°C...+60°C
Relative humidity	10%...90% without condensation
Vibrations during operation	unacceptable
Impulse waves during operation	unacceptable
Direct insolation	unacceptable
Vibrations and impulse waves during transport	PN-83/T-42106

**2. Installation.****2.1 Requirements**

AC/AC power supply is to be mounted by a qualified installer, holding relevant permits and licenses (required in installation country) to connect (interfere) with ~230 V mains supply. Unit should be mounted in confined spaces, in accordance, with normal relative humidity (RH=90% maximum) and temperature from -25°C to +40°C (table 5). PSU shall work in a vertical or horizontal position.

Before mounting the PSU module, perform a load balance. During normal operation, total current drawn by the receivers cannot exceed **I=4 A@~24 V**.

As the PSU is designed for a continuous operation and is not equipped with a power-switch, therefore an appropriate overload protection shall be guaranteed in the power supply circuit. Moreover, the user shall be informed about the method of unplugging (usually through assigning an appropriate fuse in the fuse-box). Electrical system shall follow valid standards and regulations.

**2.2 Installation procedure.****CAUTION!**

**Before installation, cut off voltage in 230V power-supply circuit. To switch power off, use an external switch, in which distance between contacts of all poles in disconnection state is not less than 3 mm.**

**It is required to install in the supply circuits, in addition to power supply, circuit breaker with 6 A nominal current.**

- 1). Mount PSU in a selected location and connect wires (tighten cable glands).
- 2). Connect power cables (~230 V) to L-N clips of PSU. Connect the ground wire to the terminal marked by the earth symbol . Use a three-core cable (with a yellow and green PE protection wire) to make the connection. Lead the cables to the appropriate terminals of the connection board through the bushing.



**Shock protection circuit shall be performed with a particular care, i.e. yellow and green wire coat of power cable shall stick to one side of terminal marked with  earth symbol in PSU enclosure. Operation of power supply without a properly made and fully operational shock protection circuit is UNACCEPTABLE! It can result in device damage or an electric shock.**

- 4). Connect conductors of consumers to terminals U1-0V and/or U2-0V of terminal box on power-supply unit (balance of power-supply load shall be performed).
- 5). Restore mains power ~230 V.
- 6). Once tests and control operation have been completed, close PSU.

**3. Operating status indication.****3.1 Technical outputs.**

The PSU is equipped with indication outputs allowing transmitting the information of casing sabotage (casing opening).

- **TAMPER: output indicates opening the power-supply unit**, output as volt-free contacts which indicate power-supply unit door status, unit closed: NC, unit opened: NO.

#### 4. Operation and use.

##### 4.1 Overload or short circuit at the PSU output.

The U1-U2-0V PSU outputs are protected against a short circuit with glass fuse. If the PSU is loaded with current exceeding 4 A@~24 V (110% for ÷ 150% of S power), there occurs the F2 and/or F1 fuse damage in the ~230 V circuit. In case of a failure, replace the fuse of the same parameters.

##### 4.2 Maintenance.

Any and all maintenance operations may be performed following the disconnection of the PSU from the power supply network. The PSU does not require performing any specific maintenance measures. However, in case of a significant dust level, clean the interior with compressed air. In case of a fuse replacement, use one of the same parameters.



##### WEEE MARK

According to EU WEE Directive – It is required not to dispose of electric or electronic waste as unsorted municipal waste and to collect such WEEE separately.



*Device works with a lead-acid battery (SLA). After the operation period it must not be disposed of but recycled according to the applicable law.*

##### **Pulsar sp. j.**

Siedlec 150, 32-744 Łapczyca, Poland

Tel. (+48) 14-610-19-40

e-mail: [biuro@pulsar.pl](mailto:biuro@pulsar.pl), [sales@pulsar.pl](mailto:sales@pulsar.pl)

[http:// www.pulsar.pl](http://www.pulsar.pl)