

DESTINATION

RACK 19" cabinet enables integrating CCTV, AC, I&HAS, RTV, LAN, or other systems in small companies or households. It is intended for devices manufactured in enclosures of 19" standard. Due to RACK cabinets, devices are aesthetically mounted and protected against mechanical damage.

TECHNICAL DATA

Mechanical parameters:

Mounting dimensions:	19" x 12U
Dimensions:	600 x 633 x 400 [mm, +/-2] Additional protective inclined top panel with height of 48 mm
Material:	cold-rolled steel SPCC, 2mm, 1.2mm, RAL7035 (grey), metallic RACK mounting rails - 2mm enclosure - 1.2mm mounting brackets - 2mm
Static load:	80 [kg]
Closing:	locked (2 keys included)
Destination:	indoor
Weight:	22.8 / 24.8 [kg]
Type Cabinets:	wall mounted fully assembled - vandal-resistant
Notes:	adjustable distance between front and rear RACK rails ventilation holes in the top panel (2 x 105x105mm - mounting dimensions) cable glands in the bottom panel - 4 x ø35mm
Warranty:	2 years
Declaration:	CE

Operating parameters:

Protection grade EN60529:	IP 20
Operating conditions:	-10°C ... +40°C
Storage temperature:	-20°C ... +60°C
Relative humidity:	20% ... 90% , without condensation
Sinusoidal vibrations during operation:	unacceptable
Impulse waves during operation:	unacceptable
Direct insolation:	unacceptable
Vibrations and impulse waves during transport:	PN-83/T-42106

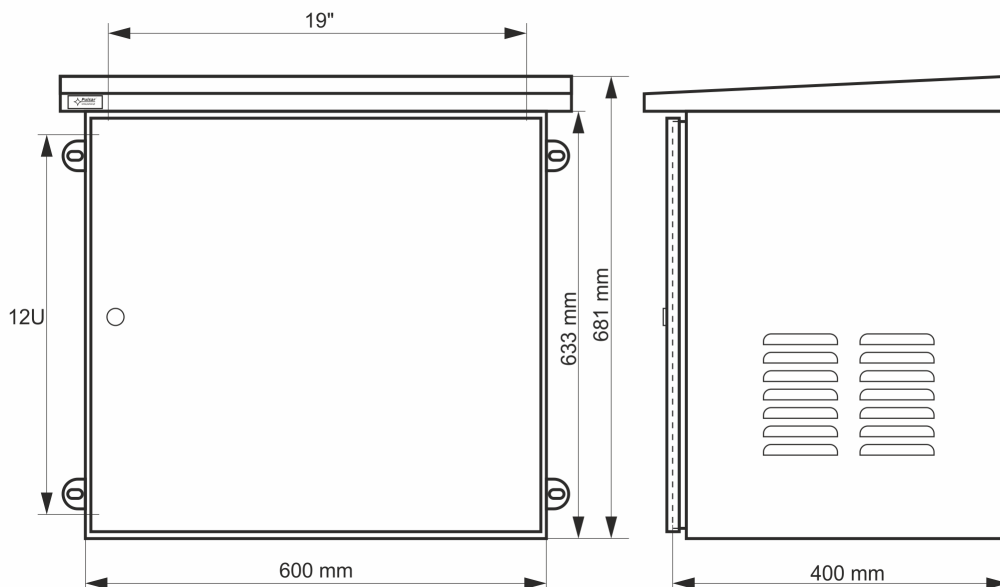



Note - The distance of the RACK profiles can be adjusted stepwise forward and backward, according to the diagram below.

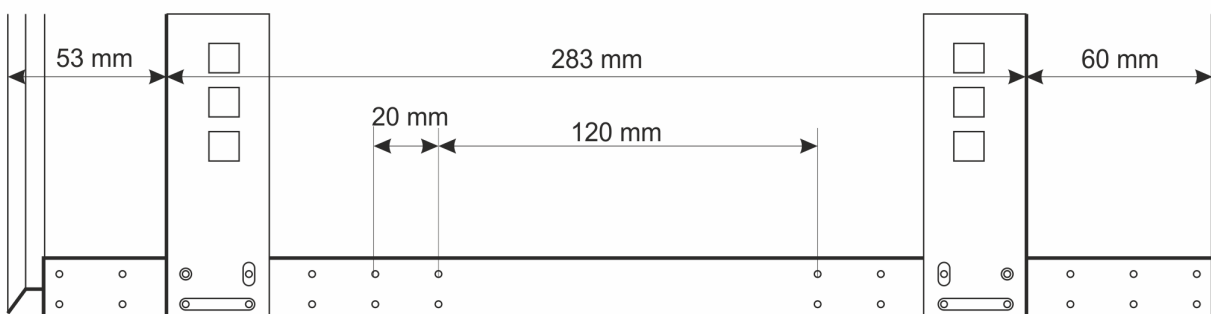
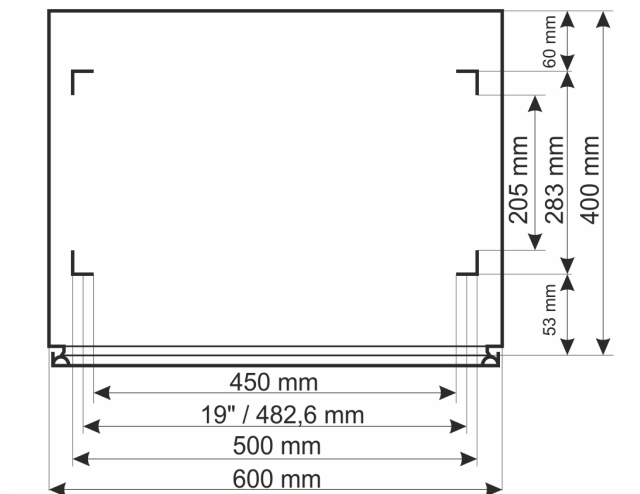

Mounting the RACK Cabinet

Choose the appropriate mounting dowels depending on the type of surface.

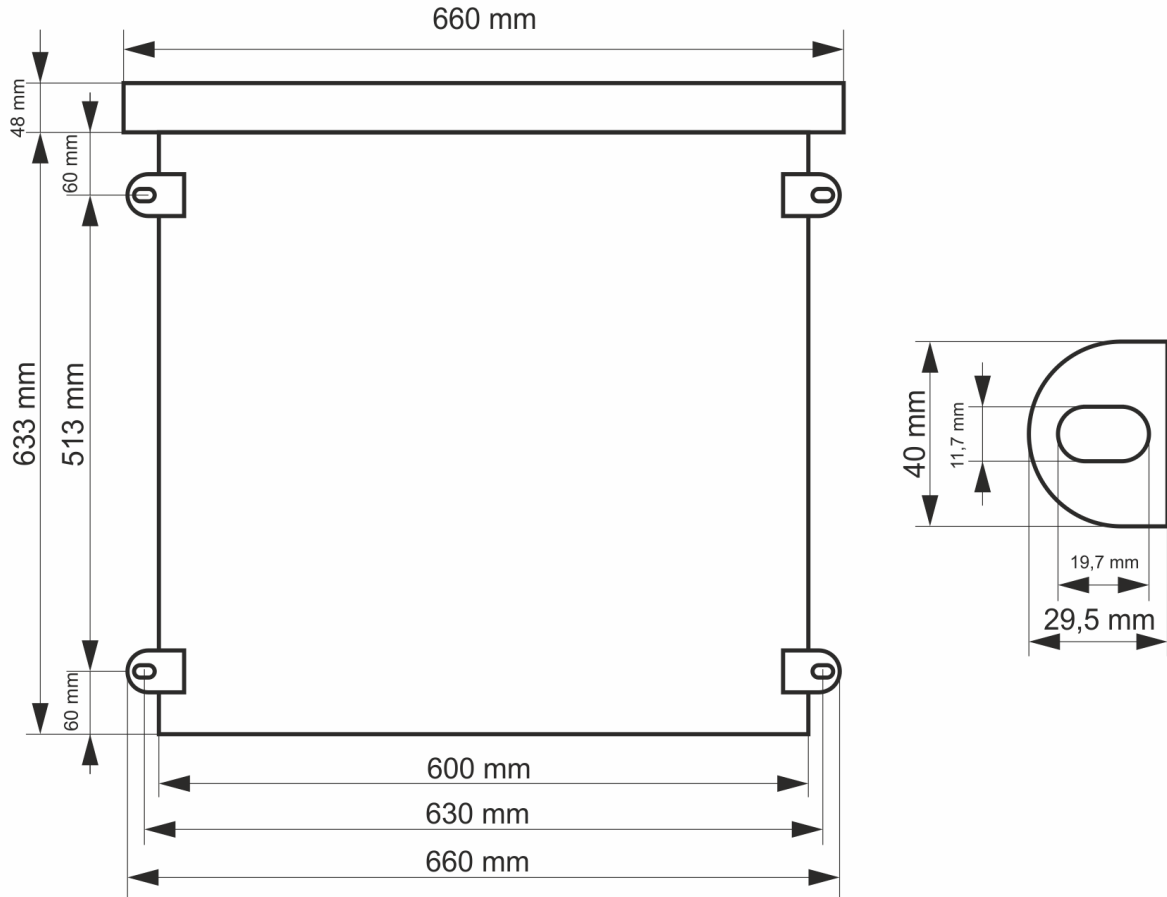

Pulsar sp. j.
Siedlec 150, 32-744 Lapczyca, Poland
Tel. +48-14-610-19-45
www.pulsar.pl
e-mail: sales@pulsar.pl

