

Features:

- 16 ports switch
16 PoE ports 10/100 Mb/s (data and power supply)
2 ports 10/100/1000 Mb/s (G1/G2 ports) (UpLink)
- **Long Range** mode (up to 250m)
- 30 W for each PoE port, supports devices compliant with the IEEE802.3af/at (**PoE+**) standard
- Supports auto-learning and auto-aging of MAC addresses (16K size)
- LED indication
- Additional assembly elements
- warranty – 2 years from production date

Example of use.

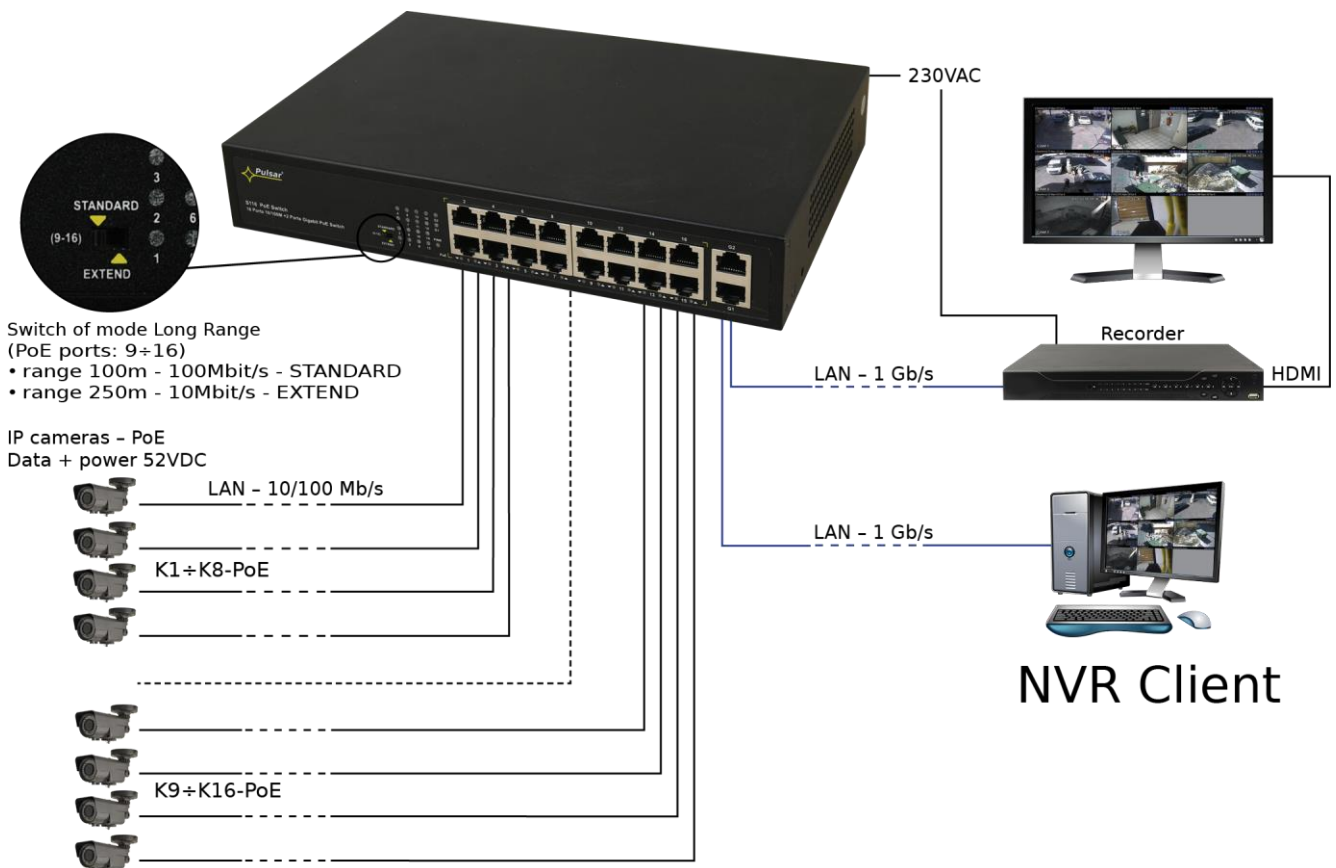

1. Technical description

1.1. General description.

S116 is a 16-ports PoE switch designed to supply IP cameras operating in IEEE 802.3af/at standard. Automatic detection of any devices powered in the PoE/PoE+ standard is enabled at the 1 – 16 ports of the switch. The G1 and G2 ports is used for connection of another network device via RJ45 connector. The LEDs at the front panel indicate the operation status (description in the table below).

The PoE technology ensures a network connection and reduces installation costs by eliminating the need to supply a separate power cable for each device. This method allows supplying other network devices, such as IP phone, wireless access point or router.

1.2 Block diagram.

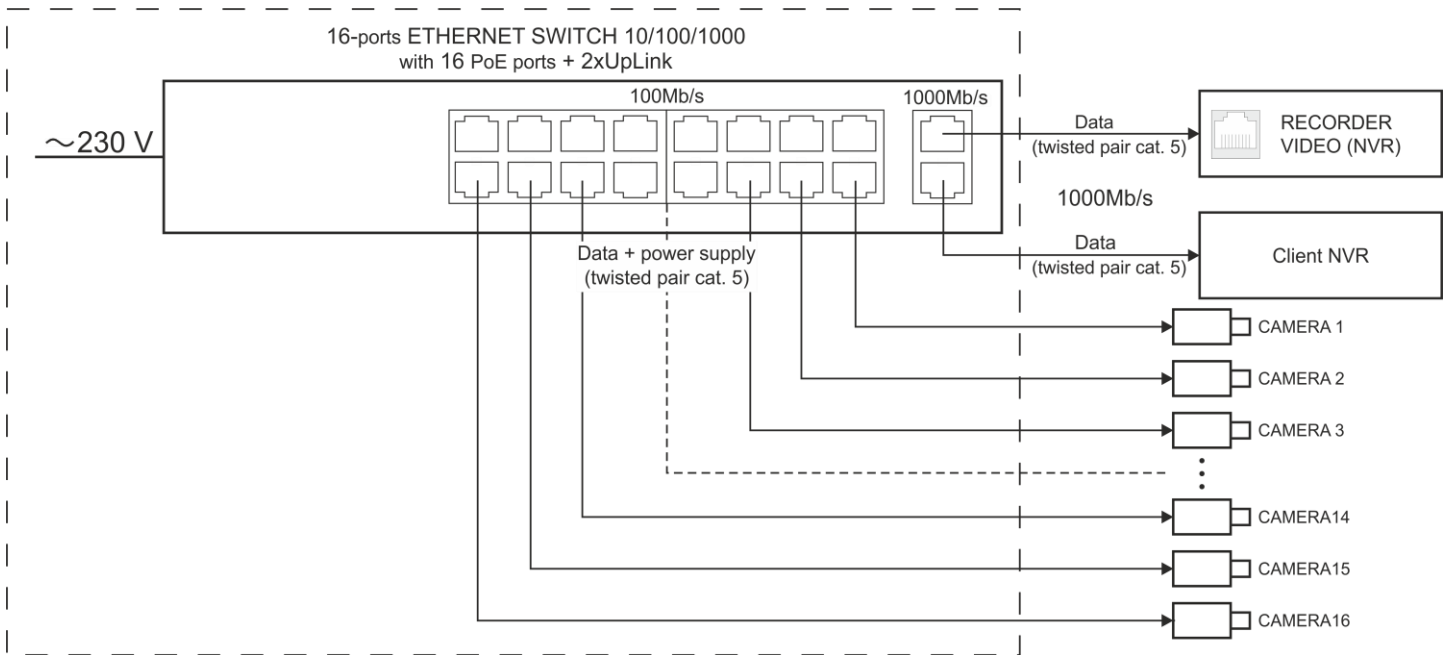

Fig. 1. Block diagram.

1.3 Description of components and connectors.

Table 1. (See Fig. 2, 3 and 4)

Component No. (Fig. 2)	Description
[1]	LED indication
[2]	16 x PoE ports (1÷16)
[3]	2 x UP LINK ports (G1, G2)
[4]	Fan
[5]	Power Socket of the AC
[6]	Switch of mode Long Range
[7]	Additional mounting elements

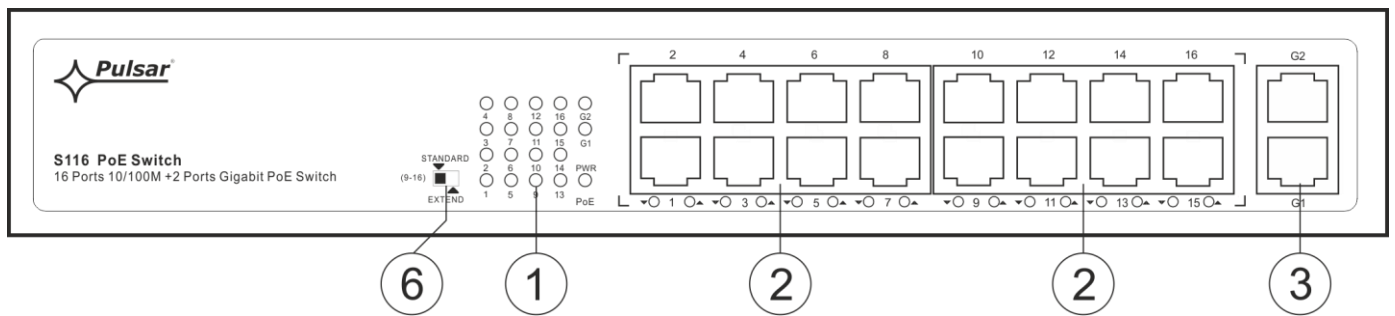

Fig. 2. The front power of the switch.

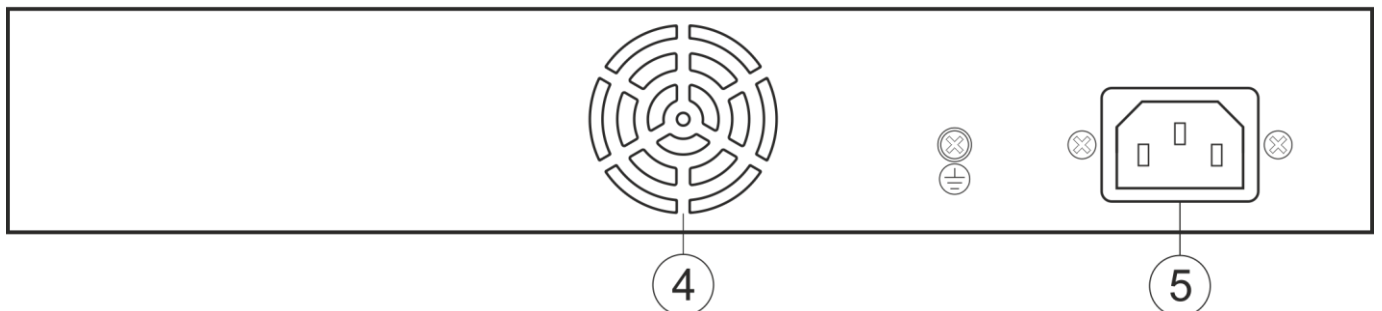

Fig. 3. Rear panel of the switch.

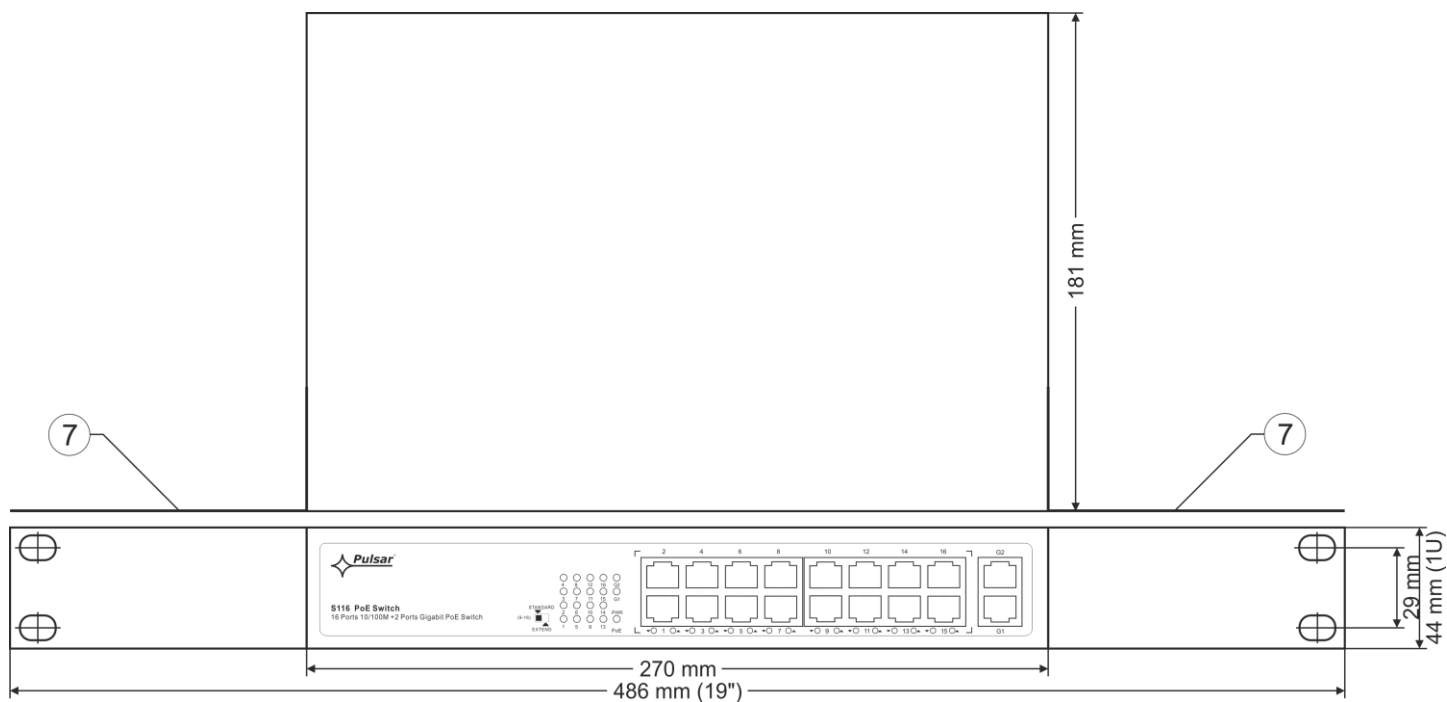

Fig. 4. The view of the switch.

1.4 Technical parameters

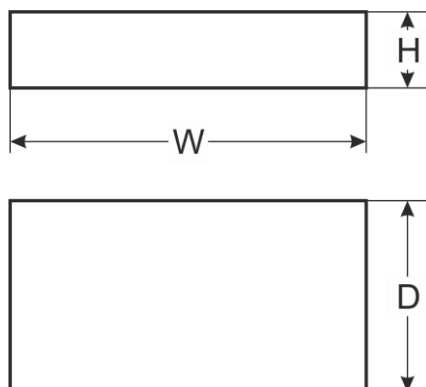

Table 2.

Ports	16 x PoE (10/100 Mb/s) (RJ-45) 2 x UpLink (10/100/1000 Mb/s) (RJ-45) with connection speed auto-negotiation and MDI/MDIX Auto Cross)
PoE power supply	IEEE 802.3af/at (1÷16 ports), 52V DC / 30W at each port *
Operating modes	Long Range
Protocols, Standards	IEEE802.3, 802.3u, 802.3x CSMA/CD, TCP/IP
Bandwidth	14,8 Gb/s
Transmission method	Store-and-Forward
Optical indication of operation	Switch power supply; Link/Act; PoE Status
Power supply	~100-240 V; 50/60 Hz; 3 A
Operating conditions	Temperature: -10°C ÷ +40°C, relative humidity 20%...90%, without condensation
Dimensions	W=270, H=44, D=181 [+/- 2mm]
Additional equipment	bracket for RACK 19"
Cable length AC	1,2m
Gross/Net weight	1,7 / 1,9 [kg]
Protection class EN 62368-1	I (first)
Storage temperature	-20°C ÷ +60°C
Declarations	CE

* The given value of 30 W per port is the maximum value. The total power consumption should not exceed 160 W when all PoE ports are being used.

2. Installation

2.1. Requirements

Unit should be mounted in confined spaces with normal relative humidity (RH=90% maximum, without condensing) and temperature from -10°C to +40°C. Ensure the free flow of air around the unit. The PSU shall work in a vertical position that guarantees sufficient convectional air-flow through ventilating holes of the enclosure.

The switch load balance should be done before installation. The given value of 30 W per port is the maximum value referring to a single output. The total power consumption should not exceed 160 W when all PoE ports are being used. The increased demand for power is particularly evident in the case of cameras with heaters or infrared illuminators - when launching these features, the power consumption increases rapidly, which may adversely affect the operation of the switch. As the device is designed for a continuous operation and is not equipped with a power-switch, therefore an appropriate overload protection in the power supply circuit should be provided. The electrical system shall be made in accordance with applicable standards and regulations.

2.2. Long Range mode

Switch enables operation in two modes: standard and extended range. When the Long Range switch is in STANDARD position (see Fig. 5), PoE ports operate at 100 Mb / s up to 100 meters. After switching to EXTEND position at the 9÷16 ports, range is increased to 250 meters and speed is reduced to 10 Mb / s. In both modes, the UpLink port speed is 1000 Mb / s.

Note: Changing the modes requires a power restart!

2.3. Installation procedure

1. Connect the 230 V power supply and turn on the device. The connection should be made with the supplied 3-core cable with a plug. The place and method of installation of the switch should ensure free air flow around the unit.
2. Connect the camera wires to the RJ45 connectors (sockets RJ45 from 1 to 16).
3. Connect the remaining LAN devices to RJ45 (G1 and G2).
4. Check the optical indication of switch operation (see Table 3).

Connection schemes

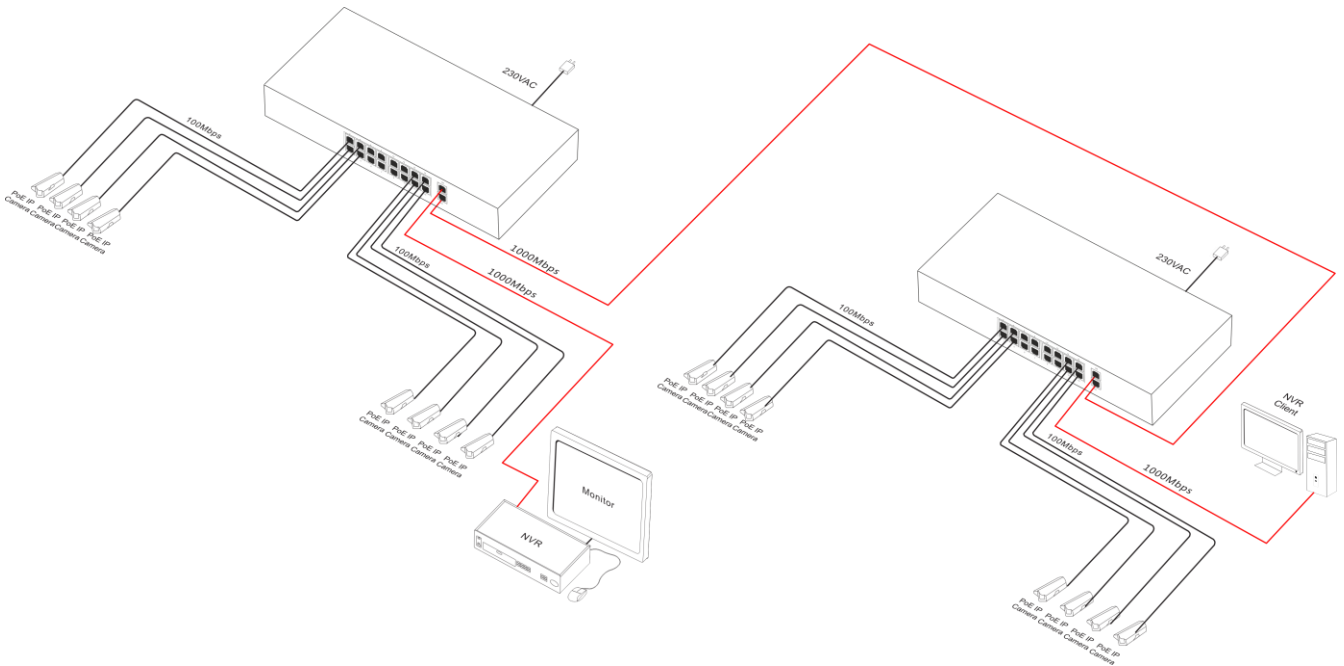



3. Operation indication.

Table 3. Operation indication

OPTICAL INDICATION OF THE SWITCH'S POWER SUPPLY

<p>GREEN LED LIGHT (Power) Indication of the switch's power supply</p> <p style="text-align: center;">PWR </p>	<p>OFF – no power supply of the switch ON – power supply on, normal operation</p>
---	---

OPTICAL INDICATION AT THE PoE PORTS (1÷16) / UpLink G1 and G2

<p>GREEN LED LIGHT (LINK/ACT) The connection status of LAN devices and data transmission</p> <p style="text-align: center;"></p>	<p>OFF - no connection ON - the device is connected Blinking – data transmission</p>
<p>GREEN LED LIGHT (PoE)</p> <p style="text-align: center;"></p>	<p>OFF - no power supply at the RJ45 port (the device is not connected or not compliant with the IEEE802.3af/at standard) ON – supply at the RJ45 port Blinking – short-circuit or output overload</p>



WEEE LABEL

Waste electrical and electronic equipment must not be disposed of with normal household waste. According to the European Union WEEE Directive, waste electrical and electronic equipment should be disposed of separately from normal household waste.

Pulsar sp. j.

Siedlec 150, 32-744 Łapczyca, Poland

Tel. (+48) 14-610-19-45

e-mail: sales@pulsar.pl

http:// www.pulsar.pl

