

■ Features

- Built-in battery charger UPS function
- TTL signals for status detection:
AC OK, Battery disconnect, Battery reverse polarity, Battery low, Battery full and Discharge (Blank version only)
- UART Communication (U version only)
- Built-in buzzer alarm (U version only)
- Built-in AC and battery circuit ON/OFF switches enhance safety during maintenance
- Forced UPS mode for battery maintenance
- Protections: Short circuit / Overload / Over voltage / Over temperature / Battery low voltage / Battery reverse polarity (No damage)
- -20 ~ +60°C wide operating temperature
- Output voltage adjustable (-20%~+5%) for CH1 by VR
- Suitable for lead acid and lithium-ion batteries
- Design refer to GB17945/GB4717(U version only) system requirement
- 1U low profile
- 3 years warranty

■ Applications

- Fire emergency and evacuation system
- Public safety battery back-up
- Security system
- Uninterruptible DC-UPS system
- Central monitoring system
- Industrial automation

■ GTIN CODE

MW Search: <https://www.meanwell.com/serviceGTIN.aspx>

■ Description

LAD-600 series is a 600W economical AC/DC low profile security power supply with UPS function. Adopting the input range from 90Vac to 264Vac (115Vac/230Vac selectable by switch) and supports output 27.6V, 41.5V and 55.2Vdc. With high efficiency up to 91% and built-in AC, battery switch for easy maintenance. In addition, LAD-600 series not only provide TTL signals for AC OK, battery disconnect, battery reverse polarity (No damage), battery low detection, battery full and discharge, but also possess UART version so the users can monitor and control the status of the units, that enhance easy way for integration into security and fire systems directly.

■ Model Encoding

LAD - 600 **B** **U**

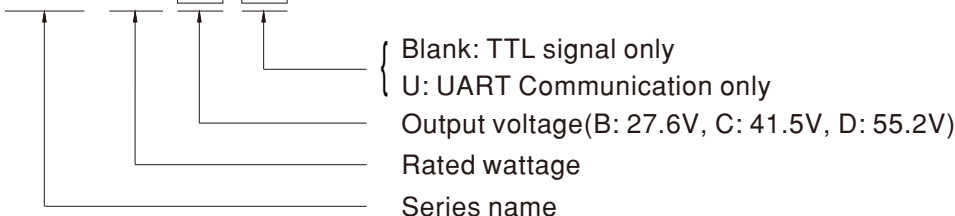

SPECIFICATION FOR TTL FUNCTION MODEL (Blank Version)

MODEL		LAD-600B		LAD-600C		LAD-600D	
OUTPUT	OUTPUT NUMBER	CH1	CH2	CH1	CH2	CH1	CH2
	DC VOLTAGE	27.6V	27.6V	41.5V	41.5V	55.2V	55.2V
	RATED CURRENT	18.74A	3A(Battery Charger)	11.45A	3A(Battery Charger)	7.87A	3A(Battery Charger)
	CURRENT RANGE	0 ~ 21.74A	-----	0 ~ 14.45A	-----	0 ~ 10.87A	-----
	RATED POWER	600.02W		599.67W		600.02W	
	RIPPLE & NOISE (max.) Note.2	270mVp-p	-----	360mVp-p	-----	360mVp-p	-----
	VOLTAGE ADJ. RANGE	CH1: 21.6 ~ 29V		CH1: 32.4 ~ 43.5V		Ch1: 43.5 ~ 58V	
	VOLTAGE TOLERANCE Note.3	±1.0%	-----	±1.0%	-----	±1.0%	-----
	LINE REGULATION	±0.5%	-----	±0.5%	-----	±0.5%	-----
	LOAD REGULATION	±0.5%	-----	±0.5%	-----	±0.5%	-----
	SETUP, RISE TIME	2000ms, 50ms/230VAC		2000ms, 50ms/115VAC at full load			
HOLD UP TIME (Typ.)	16ms/230VAC	12ms/115VAC at full load					
BATTERY STATIC DISCHARGE CURRENT	<100µA						
INPUT	VOLTAGE RANGE	90 ~ 132VAC / 180 ~ 264VAC by switch		240 ~ 370VDC (Default switch at 230VAC)			
	FREQUENCY RANGE	47 ~ 63Hz					
	EFFICIENCY (Typ.)	90%		91%		91%	
	AC CURRENT (Typ.)	12A/115VAC		7.5A/230VAC			
	INRUSH CURRENT (Typ.)	COLD START 35A/115VAC		60A/230VAC			
	LEAKAGE CURRENT	<0.5mA Peak / 240VAC					
PROTECTION	OVERLOAD Note.4	CH1:105 ~ 135% CH2:90 ~ 110%		Protection type : CH1 OLP, CH2 with battery: The unit will enter to UPS mode when CH1 is around 105%~120%, when total output of CH1 + CH2 reach around 125%~135% output shuts down CH1 OLP, CH2 without battery: Shut down o/p voltage, re-power on to removed CH2 : Constant current limiting; fault condition does not affect CH1 working, recovers automatically after fault condition is removed (External fuse is mandatory in series connection with battery for protection)			
	OVER VOLTAGE Note.4	CH1:31 ~ 36V		CH1:47 ~ 55V		CH1:59 ~ 69V	
	OVER TEMPERATURE Note.4	Protection type : Shut down o/p voltage, re-power on to removed					
	BATTERY REVERSE POLARITY	Protected when reverse polarity , no damage , recovers automatically after fault condition is removed					
	BATTERY CUTOFF	21.5V±0.5V		32V±0.5V		43V±0.5V	
	FUNCTION	AC OK	TTL signal, High / Open : AC Fail ; Low : AC OK ; Ice : max. 30mA@ 50VDC				
BATTERY DISCONNECT/ REVERSE POLARITY		TTL signal, High / Open : Battery connect/normal ; Low : Battery disconnect/reverse polarity; Ice : max. 30mA@ 50VDC					
BATTERY LOW		TTL signal, High / Open : Battery normal ; Low : Battery low; Ice : max. 30mA@ 50VDC					
BATTERY FULL		TTL signal, High / Open : Battery charging ; Low : Battery full ; Ice : max. 30mA@ 50VDC					
DISCHARGE		TTL signal, High / Open : Charge ; Low : Discharge ; Ice : max. 30mA@ 50VDC					
ENVIRONMENT		WORKING TEMP.	-20 ~ +60°C (Refer to "Derating Curve")				
	WORKING HUMIDITY	20 ~ 95% RH non-condensing					
	STORAGE TEMP., HUMIDITY	-30 ~ +85°C, 10 ~ 95% RH non-condensing					
	TEMP. COEFFICIENT	±0.03%/°C (0 ~ 50°C)					
	VIBRATION	10 ~ 500Hz, 5G 10min./1cycle, 60min. each along X, Y, Z axes					
SAFETY & EMC (Note 5 & 6)	SAFETY STANDARDS	UL62368-1, BS EN/EN62368-1, AS/NZS62368.1, EAC TP TC 004 approved; Design refer to GB 17945-2010					
	WITHSTAND VOLTAGE	I/P-O/P:3KVAC I/P-FG:2KVAC O/P-FG:0.5KVAC					
	ISOLATION RESISTANCE	I/P-O/P, I/P-FG, O/P-FG:100M Ohms / 500VDC / 25°C/ 70% RH					
	EMC EMISSION	Parameter	Standard		Test Level / Note		
		Conducted	BS EN/EN55032 (CISPR32), EAC TP TC 020		Class A		
		Radiated	BS EN/EN55032 (CISPR32), EAC TP TC 020		Class A		
		Harmonic Current	-----		-----		
		Voltage Flicker	-----		-----		
	EMC IMMUNITY	Parameter	Standard		Test Level / Note		
		ESD	BS EN/EN61000-4-2		Level 3, 8KV air ; Level 2, 6KV contact; criteria A		
Radiated		BS EN/EN61000-4-3		Level 3, 10V/m ; criteria A			
EFT / Burst		BS EN/EN61000-4-4		Level 3, 2KV ; criteria A			
Surge		BS EN/EN61000-4-5		Level 3, 1KV/Line-Line ; 2KV/Line-FG ; criteria A			
Conducted		BS EN/EN61000-4-6		Level 3, 10V ; criteria A			
Magnetic Field		BS EN/EN61000-4-8		Level 4, 30A/m ; criteria A			
OTHERS	MTBF	1154.4K hrs min. Telcordia SR-332 (Bellcore); 169.9K hrs min. MIL-HDBK-217F (25°C)					
	DIMENSION	225*124*41mm (L*W*H)					
	PACKING	1.02Kg; 12pcs/13.5Kg/0.78CUFT					

NOTE

- All parameters NOT specially mentioned are measured at 230VAC input, rated load and 25°C of ambient temperature.
- Ripple & noise are measured at 20MHz of bandwidth by using a 12" twisted pair-wire terminated with a 0.1µf & 47µf parallel capacitor.
- Tolerance : includes set up tolerance, line regulation and load regulation.
- Once the protection is triggered, the input voltage needs to be disconnected, and the cold machine will wait for 3 minutes before restarting.
- The power supply is considered a component which will be installed into a final equipment. All the EMC tests are been executed by mounting the unit on a 360mm*360mm metal plate with 1mm of thickness. The final equipment must be re-confirmed that it still meets EMC directives. All the radiation tests require an additional 20*30*13 NIZN magnetic clasp or magnetic ring to the battery output line. For guidance on how to perform these EMC tests, please refer to "EMI testing of component power supplies." (as available on <http://www.meanwell.com>)
- This power supply does not meet the harmonic current requirements outlined by BS EN/EN61000-3-2. Please do not use this power supply under the following conditions:
 - the end-devices is used within the European Union, and
 - the end-devices is connected to public mains supply with 220Vac or greater rated nominal voltage, and
 - the power supply is:
 - installed in end-devices with average or continuous input power greater than 75W, or
 - belong to part of a lighting system
 Exception: Power supplies used within the following end-devices do not need to fulfill BS EN/EN61000-3-2
 - professional equipment with a total rated input power greater than 1000W;
 - symmetrically controlled heating elements with a rated power less than or equal to 200W
- The ambient temperature derating of 3.5°C/1000m with fanless models and of 5°C/1000m with fan models for operating altitude higher than 2000m(6500ft).

※ Product Liability Disclaimer : For detailed information, please refer to <https://www.meanwell.com/serviceDisclaimer.aspx>

SPECIFICATION FOR UART COMMUNICATION FUNCTION MODEL (U Version)

MODEL		LAD-600BU		LAD-600CU		LAD-600DU	
OUTPUT	OUTPUT NUMBER	CH1	CH2	CH1	CH2	CH1	CH2
	DC VOLTAGE	27.6V	27.6V	41.5V	41.5V	55.2V	55.2V
	RATED CURRENT	18.74A	3A(Battery Charger)	11.45A	3A(Battery Charger)	7.87A	3A(Battery Charger)
	CURRENT RANGE	0 ~ 21.74A	-----	0 ~ 14.45A	-----	0 ~ 10.87A	-----
	RATED POWER	600.02W		599.67W		600.02W	
	RIPPLE & NOISE (max.) Note.2	270mVp-p	-----	360mVp-p	-----	360mVp-p	-----
	VOLTAGE ADJ. RANGE	CH1: 21.6 ~ 29V		CH1: 32.4 ~ 43.5V		CH1: 43.5 ~ 58V	
	VOLTAGE TOLERANCE Note.3	±1.0%	-----	±1.0%	-----	±1.0%	-----
	LINE REGULATION	±0.5%	-----	±0.5%	-----	±0.5%	-----
	LOAD REGULATION	±0.5%	-----	±0.5%	-----	±0.5%	-----
	SETUP, RISE TIME	2000ms, 50ms/230VAC		2000ms, 50ms/115VAC at full load			
	HOLD UP TIME (Typ.)	16ms/230VAC	12ms/115VAC at full load				
BATTERY STATIC DISCHARGE CURRENT	<100µA						
INPUT	VOLTAGE RANGE	90 ~ 132VAC / 180 ~ 264VAC by switch		240 ~ 370VDC		(Default switch at 230VAC)	
	FREQUENCY RANGE	47 ~ 63Hz					
	EFFICIENCY (Typ.)	90%		91%		91%	
	AC CURRENT (Typ.)	12A/115VAC	7.5A/230VAC				
	INRUSH CURRENT (Typ.)	COLD START 35A/115VAC		60A/230VAC			
	LEAKAGE CURRENT	<0.5mA Peak / 240VAC					
PROTECTION	OVERLOAD Note.4	CH1:105 ~ 135% CH2:90 ~ 110% Protection type : CH1 OLP, CH2 with battery: The unit will enter to UPS mode when CH1 is around 105%~120%, when total output of CH1 + CH2 reach around 125%~135% output shuts down CH1 OLP, CH2 without battery:Shut down o/p voltage, re-power on to removed CH2 : Constant current limiting; fault condition does not affect CH1 working,recovers automatically after fault condition is removed (External fuse is mandatory in series connection with battery for protection)					
	OVER VOLTAGE Note.4	CH1:31 ~ 36V		CH1:47 ~ 55V		CH1:59 ~ 69V	
	OVER TEMPERATURE Note.4	Protection type : Shut down o/p voltage, re-power on to removed					
	BATTERY REVERSE POLARITY	Protected when reverse polarity , no damage, recovers automatically after fault condition is removed					
	BATTERY CUTOFF	21.5V±0.5V		32V±0.5V		43V±0.5V	
	FUNCTION	AC OK	115VAC Input : Signals AC failure and activates when input voltage <75VAC Recover the main power supply when input voltage >87VAC 230VAC Input : Signals AC failure and activates when input voltage <165VAC Recover the main power supply when input voltage >175VAC				
CHARGER CIRCUIT FAIL		Battery disconnected, battery reverse polarity , signal failure					
BUZZER ALARM		Battery low(fire alarm system selectable by UART) AC fail, Battery low, battery disconnected, battery reverse connect, overload status (evacuation system selectable by UART)					
WORKING TEMP.		-20 ~ +60°C (Refer to "Derating Curve")					
ENVIRONMENT	WORKING HUMIDITY	20 ~ 95% RH non-condensing					
	STORAGE TEMP., HUMIDITY	-30 ~ +85°C, 10 ~ 95% RH non-condensing					
	TEMP. COEFFICIENT	±0.03%/°C (0 ~ 50°C)					
	VIBRATION	10 ~ 500Hz, 5G 10min./1cycle, 60min. each along X, Y, Z axes					
	SAFETY & EMC (Note 5 & 6)	SAFETY STANDARDS	UL62368-1, BS EN/EN62368-1, AS/NZS62368.1, EAC TP TC 004 approved; Design refer to GB 17945-2010,GB4717				
WITHSTAND VOLTAGE		I/P-O/P:3KVAC I/P-FG:2KVAC O/P-FG:0.5KVAC					
ISOLATION RESISTANCE		I/P-O/P, I/P-FG, O/P-FG:100M Ohms / 500VDC / 25°C/ 70% RH					
EMC EMISSION		Parameter	Standard		Test Level / Note		
		Conducted	BS EN/EN55032 (CISPR32), EAC TP TC 020		Class A		
		Radiated	BS EN/EN55032 (CISPR32), EAC TP TC 020		Class A		
		Harmonic Current	-----		-----		
		Voltage Flicker	-----		-----		
EMC IMMUNITY		Parameter	Standard		Test Level / Note		
		ESD	BS EN/EN61000-4-2		Level 3, 8KV air ; Level 2, 6KV contact; criteria A		
	Radiated	BS EN/EN61000-4-3		Level 3, 10V/m ; criteria A			
	EFT / Burst	BS EN/EN61000-4-4		Level 3, 2KV ; criteria A			
	Surge	BS EN/EN61000-4-5		Level 3, 1KV/Line-Line ;2KV/Line-FG ;criteria A			
	Conducted	BS EN/EN61000-4-6		Level 3, 10V ; criteria A			
	Magnetic Field	BS EN/EN61000-4-8		Level 4, 30A/m ; criteria A			
OTHERS	MTBF	1019.6K hrs min. Telcordia SR-332 (Bellcore);		144.4K hrs min. MIL-HDBK-217F (25°C)			
	DIMENSION	225*124*41mm (L*W*H)					
	PACKING	1.02Kg; 12pcs/13.5Kg/0.78CUFT					

NOTE

- All parameters NOT specially mentioned are measured at 230VAC input, rated load and 25°C of ambient temperature.
- Ripple & noise are measured at 20MHz of bandwidth by using a 12" twisted pair-wire terminated with a 0.1µf & 47µf parallel capacitor.
- Tolerance : includes set up tolerance, line regulation and load regulation.
- Once the protection is triggered, the input voltage needs to be disconnected, and the cold machine will wait for 3 minutes before restarting.
- The power supply is considered a component which will be installed into a final equipment. All the EMC tests are been executed by mounting the unit on a 360mm*360mm metal plate with 1mm of thickness. The final equipment must be re-confirmed that it still meets EMC directives. All the radiation tests require an additional 20*30*13 NIZN magnetic clasp or magnetic ring to the battery output line. For guidance on how to perform these EMC tests, please refer to "EMI testing of component power supplies." (as available on <http://www.meanwell.com>)
- This power supply does not meet the harmonic current requirements outlined by BS EN/EN61000-3-2. Please do not use this power supply under the following conditions:
 - the end-devices is used within the European Union, and
 - the end-devices is connected to public mains supply with 220Vac or greater rated nominal voltage, and
 - the power supply is:
 - installed in end-devices with average or continuous input power greater than 75W, or
 - belong to part of a lighting system
 Exception: Power supplies used within the following end-devices do not need to fulfill BS EN/EN61000-3-2
 - professional equipment with a total rated input power greater than 1000W;
 - symmetrically controlled heating elements with a rated power less than or equal to 200W
- The ambient temperature derating of 3.5°C/1000m with fanless models and of 5°C/1000m with fan models for operating altitude higher than 2000m(6500ft).

※ Product Liability Disclaimer : For detailed information, please refer to <https://www.meanwell.com/serviceDisclaimer.aspx>

Block Diagram

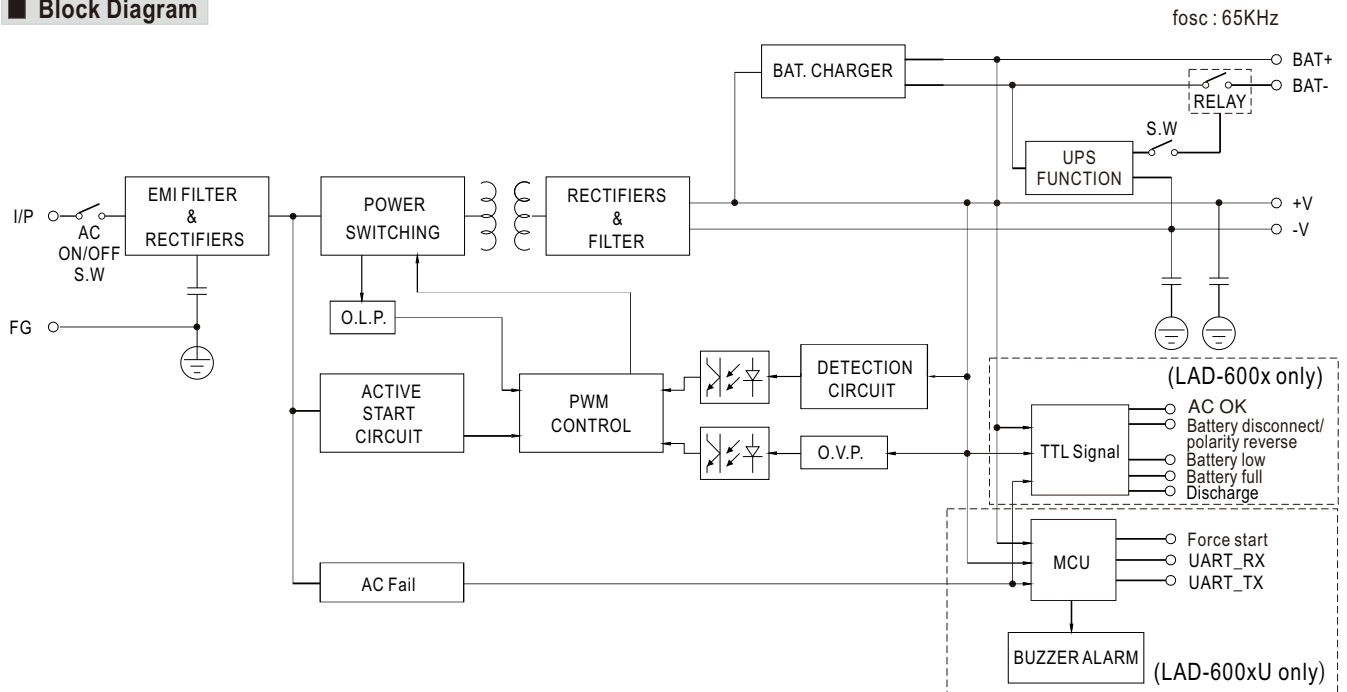

Derating Curve

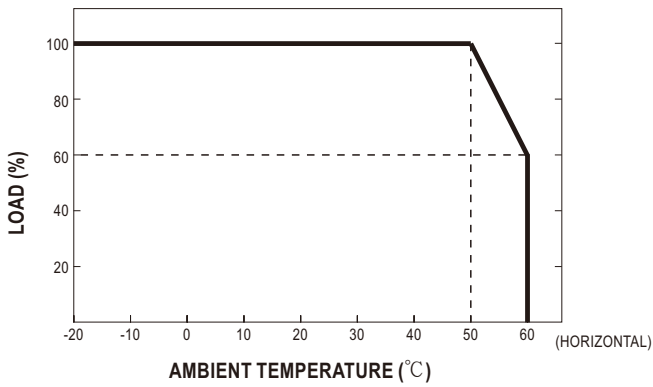

Static Characteristics

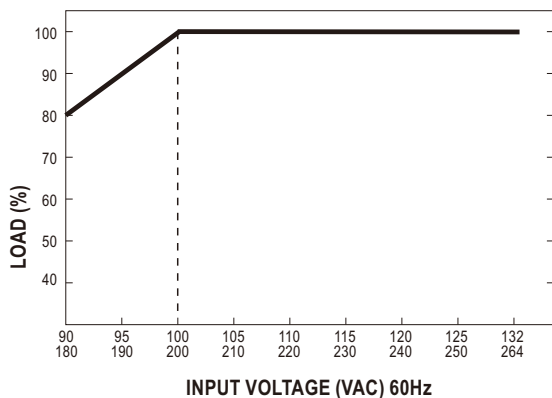

■ **Suggested Application**

1.DC-UPS function

When AC voltage drops below 75/165VAC, The UPS function will activate and power source switch battery backup.

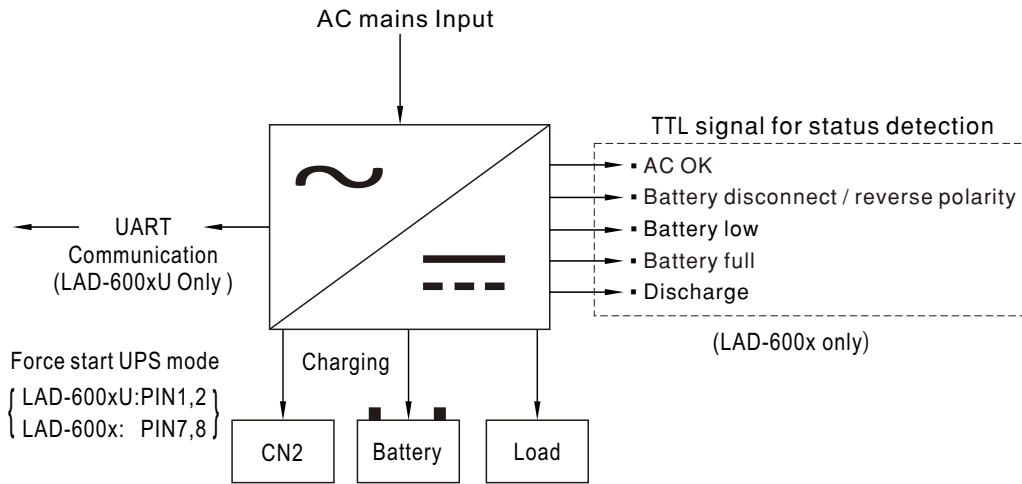

2.UART Communication Function (U version only)

The power supply uploads various fault signals, power supply working status, single battery voltage, main voltage, output voltage and output current to the controller through the UART, and changes the power supply working status according to the controller instructions. For details, please refer to the user manual.

2.1 Forced Start & Remote UPS Control(U version only)

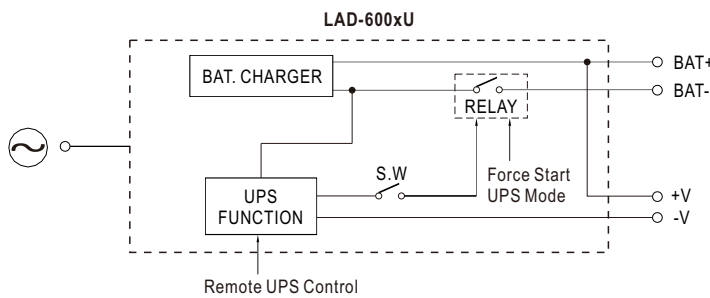

※ Force start UPS mode:

According to fire safety regulation, UPS power supply must equip with force start UPS function. In case of emergency, maintenance or testing, personal can active the UPS mode of by shorting PIN1 and PIN2 of LAD-600xU to ensure the energy supply to the loads. When operating under UPS mode, the BAT. UVP alarm is still active, but the BAT. UVP protection will be disable, therefore, the battery will be fully discharged until system shuts down.

Pin 1 & 2	Status
Short	Forced start
Open	Normal



Note:

1st priority of UPS mode: Force start UPS function by internal relay.

※ Remote UPS mode:

According to fire safety regulation, UPS power supply must equip with remote UPS function. So the power supply unit can be linked to the fire alarm system, user's system will be able to detect the status of PIN3 and PIN4 LAD-600xU with UART communication. When PIN 3 and PIN 4 is shorted, the power supply will enter remote UPS mode, therefore the UPS mode will be active and the status signal will also send to the fire alarm system for indication. Personal or the system can use the signal as trigger threshold for other alarm systems to decide when and how to enter the emergency sequence. Under this condition, BAT. UVP alarm and protection are still active.

Pin 3 & 4	Status
Short	Remote UPS control
Open	Normal

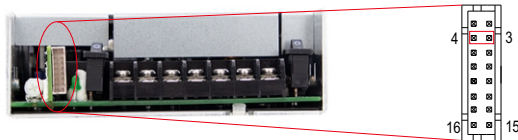

Note:

2nd priority of UPS mode: UPS function can be activate by controlling with this signal, since the controller is still normal, the relay can be controlled through communication protocol.

2.2 Charging Curve for Different Battery(U version only)

Pin 5 & 6	Battery Type
Short	Li-ion batteries
Open	Lead-acid (Pb) batteries

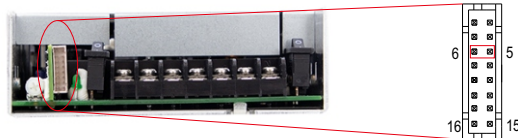

☉ Charging curve

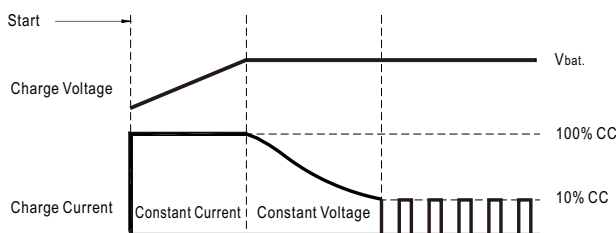

☉ Apply to Lead-acid batteries

☉ Charging curve

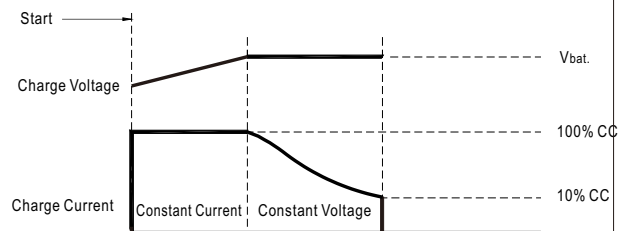

☉ Apply to Li-ion batteries

2.3 Mode Selection for Buzzer(U version only)

Pin 7 & 8	Status
Short	Fire alarm system
Open	Evacuation system

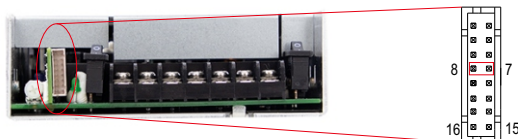

Note:

LAD-600BU Open circuit for fire alarm, Short circuit for evacuation ; LAD-600CU/DU Open circuit for evacuation, Short circuit for fire alarm.

2.4 Battery Inspection

※ LAD-600BU

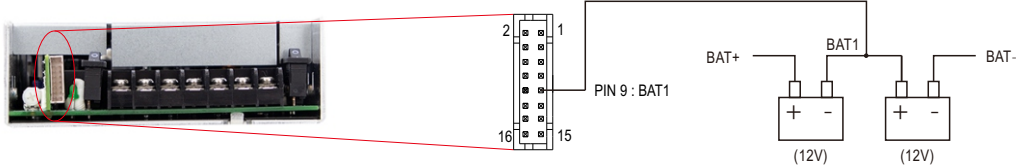

※ LAD-600CU

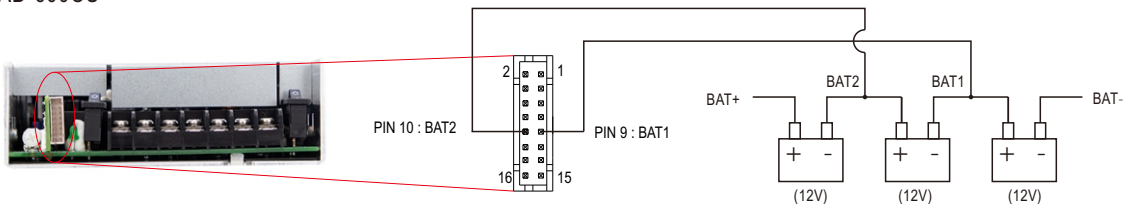

※ LAD-600DU

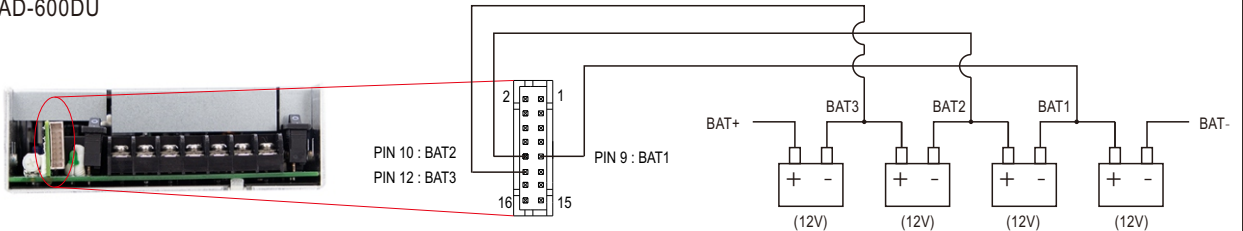

2.5 UART Communication Interface(U version only)

Communication provides functions such as control, setting, and monitoring.

The parameters include the backup power switch, battery undervoltage point ,etc.



3.Function signals by TTL and UART

- TTL Signal is sent out through pins from CN2.
- External voltage source is required for the TTL signal. The maximum voltage is 50VDC and the maximum sink current is 30mA.

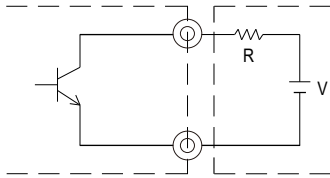

External voltage and resistor
(The max. sink current is 30mA at 50VDC)

3.1 AC OK : Detection of AC status

- TTL Signal for Blank version

Between pin 1 and pin 4	Description
Low (0.3V max. at 30mA)	The signal is "Low" when the AC input is normal
High or open (External applied voltage 50V max.)	The signal turns to be "High" when the AC input is abnormal

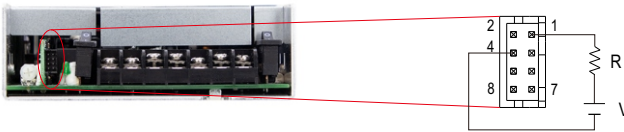

- Signal for UART Version

AC OK is achievable through UART communication protocol, please refer to for more detail: <http://www.meanwell.com/manual.html>

3.2 Battery Disconnected/Reverse Polarity: Battery status detection

- TTL Signal for Blank version

Between pin 2 and pin 4	Description
Low (0.3V max. at 30mA)	The signal is "Low" when the battery is not connected or inversely connected
High or open (External applied voltage 50V max.)	The signal turns to be "High" when the battery is connected or normal

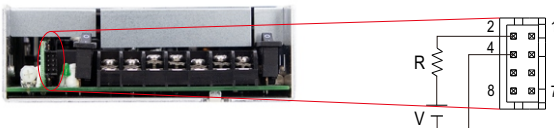

Note. The signals of battery disconnected and reverse polarity can only be detected during the first power transmission , it is can not be detected at any time.

- Signal for UART Version

Battery Disconnected/Reverse Polarity is achievable through UART communication protocol, please refer to for more detail: <http://www.meanwell.com/manual.html>

3.3 Battery Low: Battery low detection

- TTL Signal for Blank version

Between pin 3 and pin 4	Description
Low (0.3V max. at 30mA)	The signal is "Low" when the battery is under voltage protected
High or open (External applied voltage 50V max.)	The signal turns to be "High" when the battery is normal



- Signal for UART Version

Battery Low is achievable through UART communication protocol, please refer to for more detail:

<http://www.meanwell.com/manual.html>

3.4 Battery Full : Battery full detection

- TTL Signal for Blank version

Between pin 4 and pin 5	Description
Low (0.3V max. at 30mA)	The signal is "Low" when the battery is fully charged
High or open (External applied voltage 50V max.)	The signal turns to be "High" when the battery is charged

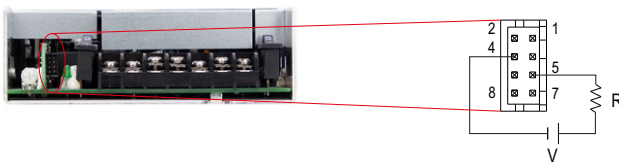

- Signal for UART Version

Battery Full is achievable through UART communication protocol, please refer to for more detail:

<http://www.meanwell.com/manual.html>

3.5 Discharge: Discharge detection

- TTL Signal for Blank version

Between pin 4 and pin 6	Description
Low (0.3V max. at 30mA)	The signal is "Low" when the power supply is discharging
High or open (External applied voltage 50V max.)	The signal is "High" when the main power is working

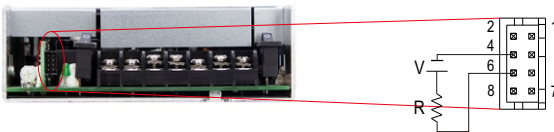

- Signal for UART Version

Discharge is achievable through UART communication protocol, please refer to for more detail:

<http://www.meanwell.com/manual.html>

3.6 Forced Start: Forced start UPS mode

- TTL Signal for Blank version

Pin 7 & 8	Status
Short	Forced start UPS mode
Open	Normal



- Signal for UART Version

Forced Start is achievable through UART communication protocol, please refer to for more detail:

<http://www.meanwell.com/manual.html>

Mechanical Specification

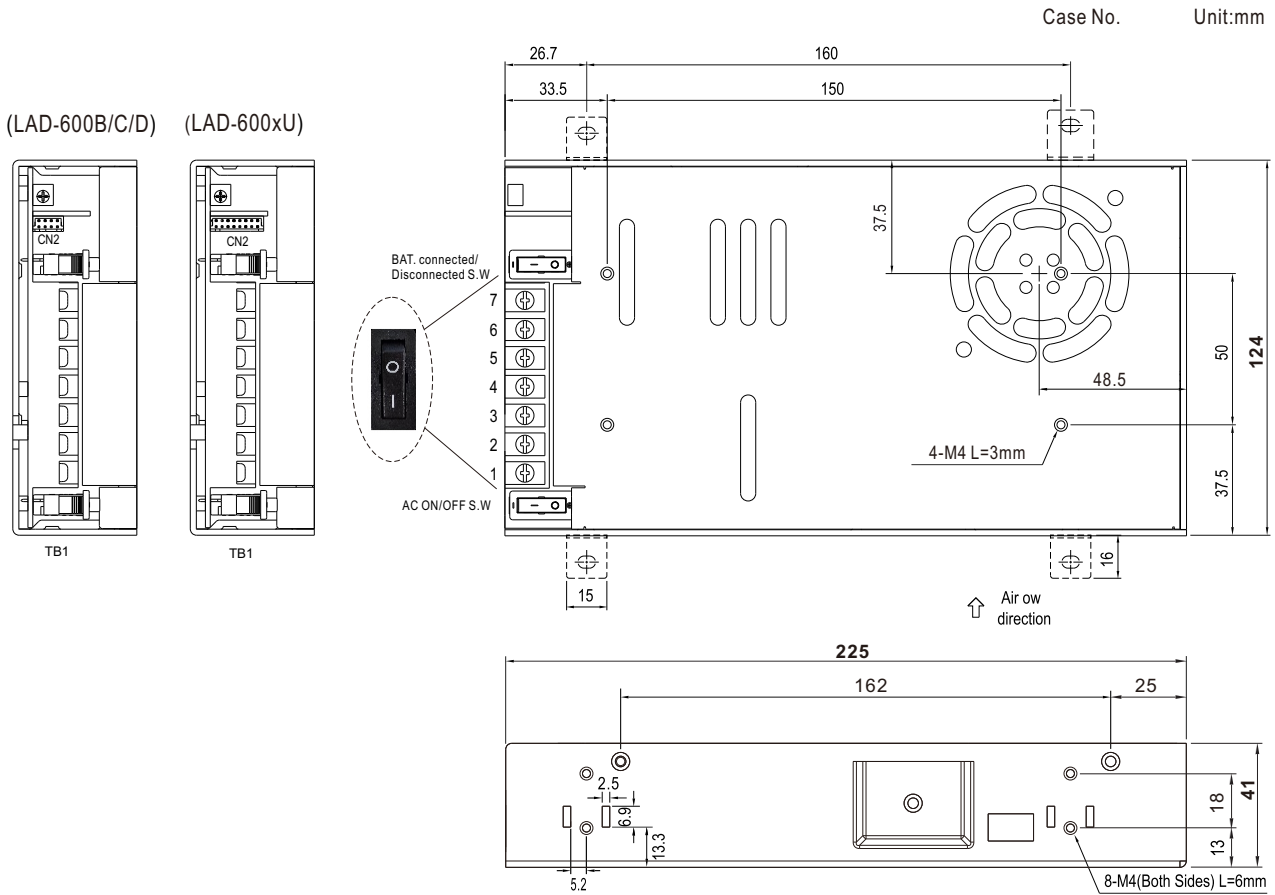

※ Connector Pin No. Assignment(CN2) (LAD-600x)

Pin No.	Assignment(TTL Signal)	Mating Housing	Terminal
1	AC OK	TKP DH2 or equivalent	TKP or equivalent
2	Battery disconnect/ reverse polarity		
3	Battery low		
4	GND		
5	Battery full		
6	Discharge		
7,8	Open : normal Short : forced start UPS mode		

※ Connector Pin No. Assignment(CN2) (LAD-600xU)

Pin No.	Assignment	Mating Housing	Terminal
1,2	Short : forced start	TKP DH2 or equivalent	TKP or equivalent
	Open : normal		
3,4	Short : Remote UPS control		
	Open : normal		
5,6	Short : Li- ion batteries		
	Open : Lead-acid (Pb) batteries		
7,8	Fire alarm/ Evacuatiione option		
9	BAT1		
10	BAT2		
11	NC		
12	BAT3		
13	UART_RX		
14	UART_TX		
15	GND		
16	3.3V		

※ Terminal Pin No. Assignment(TB1)

Pin No.	Assignment
1	AC/L
2	AC/N
3	FG \perp
4	DC OUTPUT -V
5	DC OUTPUT +V
6	BAT -
7	BAT +

+3.3V(ref) for testing use only;can't supply power over 1mA for a long time



DC OUTPUT -V and BAT - can not be shorted.

■ **Accessory List**

※ Bracket (Optional accessory, Should ordered separately)

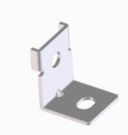
MW's Order No.	Item	Quantity
DGG2MHS012		4pcs/per model

■ **Installation Diagram**

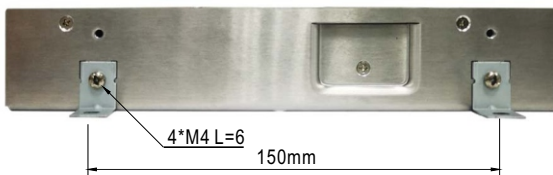
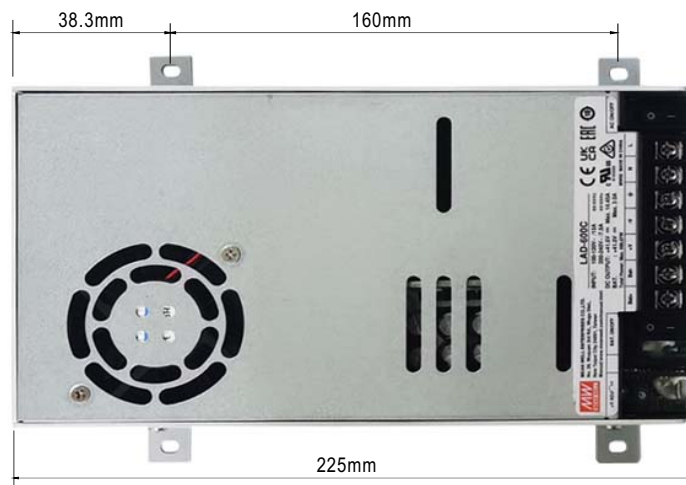
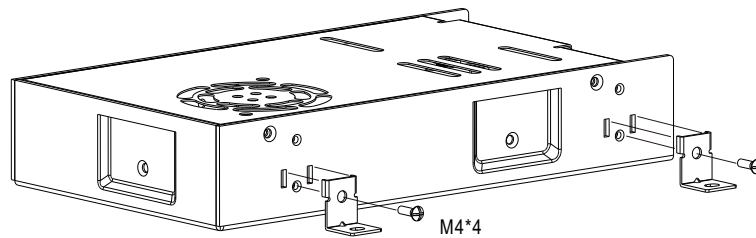

■ **Installation Manual**

Please refer to : <http://www.meanwell.com/manual.html>