

CODE: **RAC168M** v1.0/II
NAME: **Plinth 100mm for floor standing cabinets 600x800mm**

EN

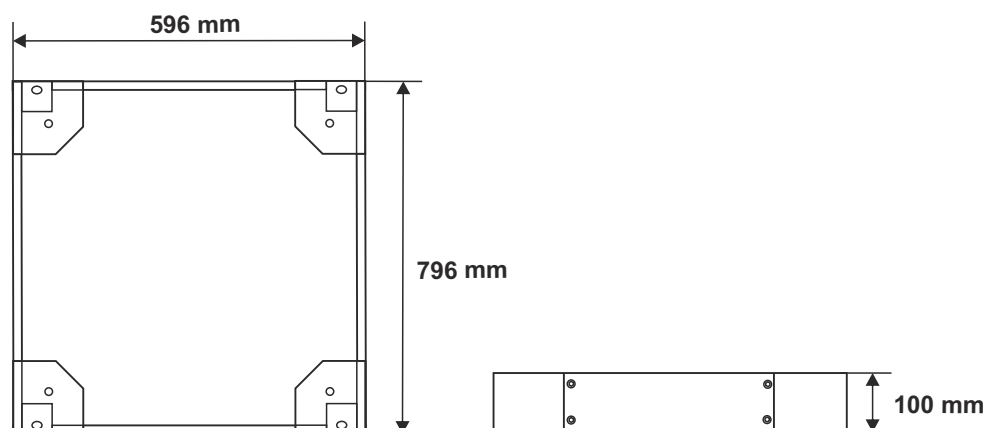

DESTINATION

The 100mm plinth is intended for 600x800mm floor standing cabinets. It enables stabilising the cabinet and fixing it to the floor.

TECHNICAL DATA

Dimensions:	W=596, H=100, D=796 [mm, +/-2]
Net/gross weight:	5,3 / 5,6 [kg]
Material:	1,2mm and 2mm cold-rolled steel (SPCC), RAL 9004
Destination:	inside
Warranty:	1 year from production date
Notes:	- mounted to the bottom of a RACK cabinet - 4 M12 screws (hex socket head)