

CODE: RAC188 v1.0/II

EN

NAME: Plinth 100mm for floor standing cabinets 800x800mm

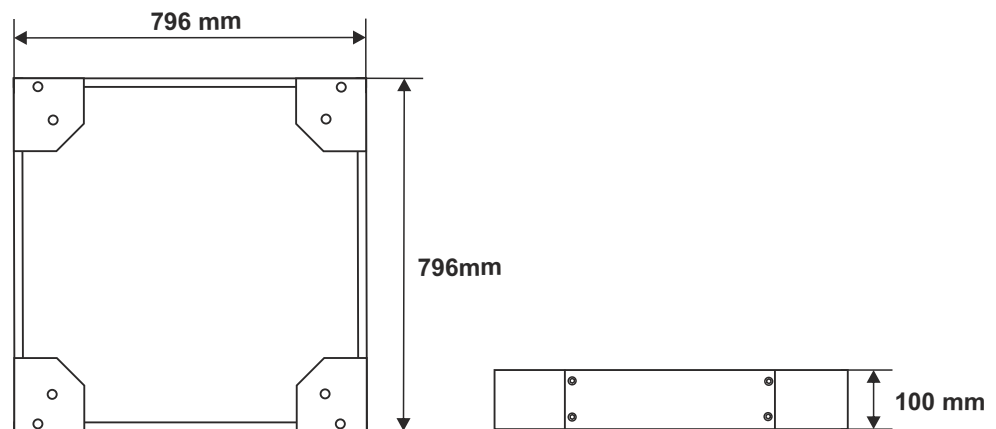

#### DESTINATION

The 100mm plinth is intended for 800x800mm floor standing cabinets. It enables stabilising the cabinet and fixing it to the floor.

#### TECHNICAL DATA

<b>Dimensions:</b>	W=796, H=100, D=796 [mm, +/-2]
<b>Net/gross weight:</b>	5,8 / 6,5 [kg]
<b>Material:</b>	1,2mm and 2mm cold-rolled steel (SPCC), RAL 9004
<b>Destination:</b>	inside
<b>Warranty:</b>	1 year from production date
<b>Notes:</b>	- mounted to the bottom of a RACK cabinet - 4 M12 screws (hex socket head) + washers included