



## Features

- Constant Power mode output
- Metal housing design with functional Ground
- Built-in active PFC function
- Class 2 power unit
- No load / Standby power consumption <0.5W
- IP67 rating for indoor or outdoor installations
- Function options: output adjustable via potentiometer  
3 in 1 dimming function (Dim to off and Isolation design)
- Typical lifetime>50000 hours
- 5 years warranty

## Applications

- LED street lighting
- LED architectural lighting
- LED bay lighting
- LED floodlighting
- Type "HL" for use in Class I, Division 2 hazardous (Classified) location.

## GTIN CODE

MW Search: <https://www.meanwell.com/serviceGTIN.aspx>

## Description

XLG-50 series is a 50W AC/DC LED driver featuring the constant power mode output. XLG-50 operates from 90~305VAC. Thanks to the high efficiency up to 90%, The entire series is able to operate between -40°C~90°C wide case temperature range with air convection. The design of metal housing and IP67 ingress protection level allows this series to fit both indoor and outdoor applications. XLG-50 is equipped with various function options, such as dimming methodologies, so as to provide the optimal design flexibility for LED lighting system. XLG-50 series comply with the latest version of IEC61347/GB19510.1 and UL8750 international safety regulations. The output and dimming circuit are also completely in accordance with the new regulations with isolation to ensure the safety of both user and luminaire system during installation.

## Model Encoding

XLG - 50 **I** - **A**

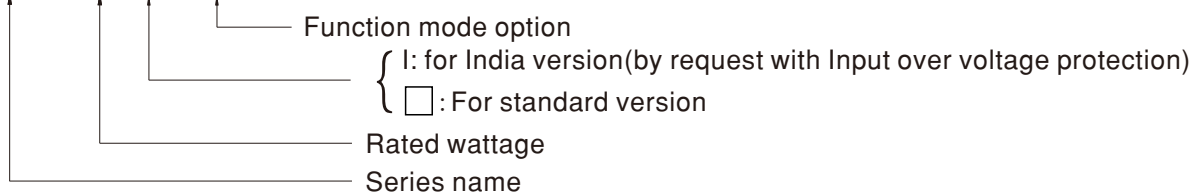

Type	IP Level	Function	Note
A	IP67	Io adjustable through built in potentiometer.	In Stock
AB	IP67	Io adjustable through built in potentiometer 3 in 1 dimming function (0~10Vdc, 10V PWM signal and resistance)	In Stock

Note: India version needs MOQ for production, please consult MEANWELL for detail

**SPECIFICATION**

<b>MODEL</b>		XLG-50 □ - □		
<b>OUTPUT</b>	<b>RATED CURRENT (Default)</b>	1A		
	<b>CONSTANT CURRENT REGION Note.2</b>	22 ~ 54V		
	<b>RATED POWER</b>	100VAC ~ 305VAC 50W		
	<b>CURRENT RIPPLE</b>	5.0% max. @rated current		
	<b>OPEN CIRCUIT VOLTAGE (max.)</b>	57V		
	<b>CURRENT ADJ. RANGE</b>	0.53 ~ 2.1A		
	<b>SETUP, RISE TIME Note.3</b>	500ms, 100ms/115VAC, 230VAC		
<b>INPUT</b>	<b>VOLTAGE RANGE Note.4</b>	90 ~ 305VAC 127 ~ 431VDC (Please refer to "STATIC CHARACTERISTIC" section)		
	<b>FREQUENCY RANGE</b>	47 ~ 63Hz		
	<b>POWER FACTOR</b>	PF ≥ 0.97/115VAC, PF ≥ 0.95/230VAC, PF ≥ 0.92/277VAC@full load (Please refer to "POWER FACTOR (PF) CHARACTERISTIC" section)		
	<b>TOTAL HARMONIC DISTORTION</b>	THD < 10% (@load ≥ 50%/115VAC, 230VAC; @load ≥ 75%/277VAC) (Please refer to "TOTAL HARMONIC DISTORTION(THD)" section)		
	<b>EFFICIENCY (Typ.) Note.10</b>	90%		
	<b>AC CURRENT</b>	0.57A / 115VAC 0.29A / 230VAC 0.24A/277VAC		
	<b>INRUSH CURRENT(Typ.)</b>	COLD START 50A(twidth=350µs measured at 50% Ipeak) at 230VAC; Per NEMA 410		
	<b>MAX. No. of PSUs on 16A CIRCUIT BREAKER</b>	5 units (circuit breaker of type B) / 8 units (circuit breaker of type C) at 230VAC		
	<b>LEAKAGE CURRENT</b>	<0.75mA / 277VAC		
	<b>NO LOAD / STANDBY POWER CONSUMPTION</b>	No load power consumption <0.5W for A, <0.75W for I series Standby power consumption <0.5W for AB-Type(Dimming OFF)		
<b>PROTECTION</b>	<b>OVER POWER</b>	110-150% Over Power Protection, recovers automatically after fault condition is removed		
	<b>SHORT CIRCUIT</b>	Constant current limiting, recovers automatically after fault condition is removed		
	<b>OVER TEMPERATURE</b>	Hiccup mode, recovers automatically after fault condition is removed		
	<b>INPUT OVER VOLTAGE Note.8</b>	320 ~ 370VAC (Shut down output voltage when the input voltage exceeds protection voltage, recovers automatically after fault condition is removed) Can survive input voltage stress of 440Vac for 48 hours		
	<b>WORKING TEMP.</b>	Tcase = -40 ~ +90°C (Please refer to "OUTPUT LOAD vs TEMPERATURE" section)		
<b>ENVIRONMENT</b>	<b>MAX. CASE TEMP.</b>	Tcase = +90°C		
	<b>WORKING HUMIDITY</b>	20 ~ 95%		
	<b>STORAGE TEMP.</b>	-40 ~ +80°C		
	<b>TEMP. COEFFICIENT</b>	±0.03%/°C (0 ~ 60°C)		
	<b>VIBRATION</b>	10 ~ 500Hz, 5G 12min./1cycle, period for 72min. each along X, Y, Z axes		
	<b>SAFETY &amp; EMC</b>	<b>SAFETY STANDARDS Note.8</b>	UL8750(type"HL"), CSA C22.2 No. 250.13-12; ENEC AS/NZS IEC BS EN/EN61347-1, AS/NZS BS EN/EN61347-2-13 independent, BS EN/EN62384; IP67; GB19510.1, GB19510.14, EAC TP TC 004, J61347-1(H29), J61347-2-13(H29), KC61347-1, KC61347-2-13, IS15885(Part2/Sec13)( for XLG-50l type only); NOM-058-SCFI-2017 approved	
<b>WITHSTAND VOLTAGE</b>		I/P-O/P:3.75KVAC I/P-FG:2.0KVAC O/P-FG:1.5KVAC		
<b>ISOLATION RESISTANCE</b>		I/P-O/P, I/P-FG, O/P-FG:100M Ohms / 500VDC / 25°C / 70% RH		
<b>EMC EMISSION</b>		<b>Parameter</b>	<b>Standard</b>	<b>Test Level/Note</b>
		Conducted	BS EN/EN55015(CISPR15) ,GB/T17743	-----
		Radiated	BS EN/EN55015(CISPR15) ,GB/T17743	-----
		Harmonic Current	BS EN/EN61000-3-2 ,GB/T17625.1	Class C @load ≥ 50%
		Voltage Flicker	BS EN/EN61000-3-3	-----
<b>EMC IMMUNITY</b>		BS EN/EN61547		
		<b>Parameter</b>	<b>Standard</b>	<b>Test Level/Note</b>
	ESD	BS EN/EN61000-4-2	Level 3, 8KV air ; Level 2, 4KV contact	
	Radiated	BS EN/EN61000-4-3	Level 3	
	EFT/Burst	BS EN/EN61000-4-4	Level 3	
	Surge	BS EN/EN61000-4-5	4KV/Line-Line 6KV/Line-Earth	
	Conducted	BS EN/EN61000-4-6	Level 3	
	Magnetic Field	BS EN/EN61000-4-8	Level 4	
Voltage Dips and Interruptions	BS EN/EN61000-4-11	>95% dip 0.5 periods, 30% dip 25 periods, >95% interruptions 250 periods		
<b>OTHERS</b>	<b>MTBF</b>	3931.6 K hrs min. Telcordia SR-332 (Bellcore) 394.6Khrs min. MIL-HDBK-217F (25°C)		
	<b>DIMENSION</b>	105*63*30mm (L*W*H)		
	<b>PACKING</b>	0.41Kg;24pcs/ 10.5Kg/0.81CUFT for A-type 0.42Kg;24pcs/ 11Kg/0.81CUFT for AB-type		
<b>NOTE</b>	<ol style="list-style-type: none"> <li>All parameters NOT specially mentioned are measured at 230VAC input, rated current and 25°C of ambient temperature.</li> <li>Please refer to "DRIVING METHODS OF LED MODULE".</li> <li>Length of set up time is measured at first cold start. Turning ON/OFF the driver may lead to increase of the set up time.</li> <li>De-rating may be needed under low input voltages. Please refer to "STATIC CHARACTERISTIC" sections for details.</li> <li>The driver is considered as a component that will be operated in combination with final equipment. Since EMC performance will be affected by the complete installation, the final equipment manufacturers must re-qualify EMC Directive on the complete installation again.</li> <li>This series meets the typical life expectancy of &gt;50,000 hours of operation when Tease, particularly (C) point (or TMP, per DLC), is about 75°C or less.</li> <li>Please refer to the warranty statement on MEAN WELL's website at <a href="http://www.meanwell.com">http://www.meanwell.com</a></li> <li>Input over voltage only for XLG-50 I series ,and I series without UL/CSA certificate.</li> <li>The ambient temperature derating of 3.5°C/1000m with fanless models and of 5°C/1000m with fan models for operating altitude higher than 2000m(6500ft).</li> <li>Only for XLG-50-A</li> <li>Products sourced from the Americas regions may not have the CCC/PSE/BIS/KC logo. Please contact your MEAN WELL sales for more information.</li> <li>For any application note and IP water proof function installation caution, please refer our user manual before using. <a href="https://www.meanwell.com/Upload/PDF/LED_EN.pdf">https://www.meanwell.com/Upload/PDF/LED_EN.pdf</a></li> <li>Ripple &amp; noise are measured at 20MHz of bandwidth by using a 12" twisted pair-wire terminated with a 0.1µf &amp; 47µf parallel capacitor.</li> <li>To fulfill requirements of the latest ErP regulation for lighting fixture, this LED driver can only be used behind a switch without permanently connected to the mains.</li> <li>If you need the NOM (Mexico) certificate, Please contact MEAN WELL sales representative for details.</li> </ol>			
<p>※ Product Liability Disclaimer : For detailed information, please refer to <a href="https://www.meanwell.com/serviceDisclaimer.aspx">https://www.meanwell.com/serviceDisclaimer.aspx</a></p>				

■ Block Diagram

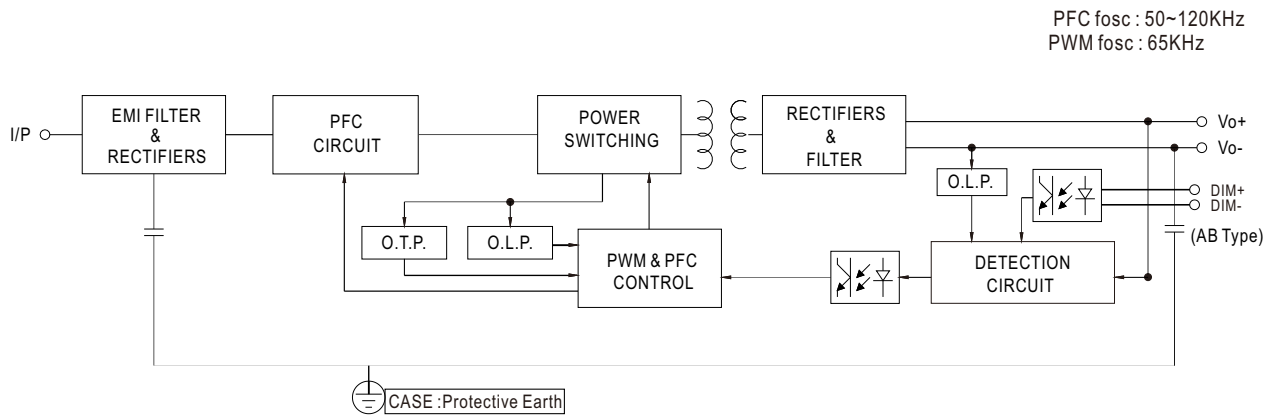

■ DRIVING METHODS OF LED MODULE

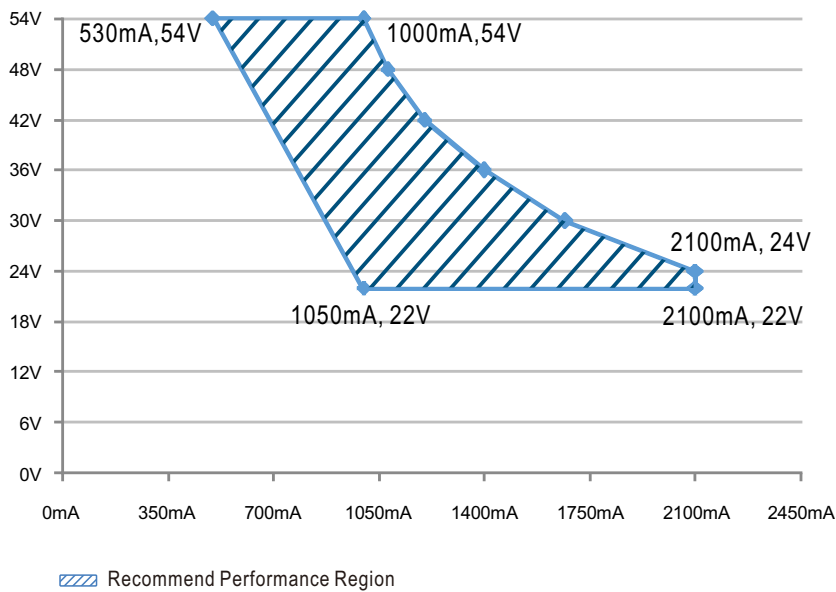

**■ DIMMING OPERATION**



※ **3 in 1 dimming function (for AB-Type)**

- Output constant current level can be adjusted by applying one of the three methodologies between DIM+ and DIM-: 0 ~ 10VDC, or 10V PWM signal or resistance.
- Direct connecting to LEDs is suggested. It is not suitable to be used with additional drivers.
- Dimming source current from power supply: 100 $\mu$ A (typ.)

◎ Applying additive 0 ~ 10VDC

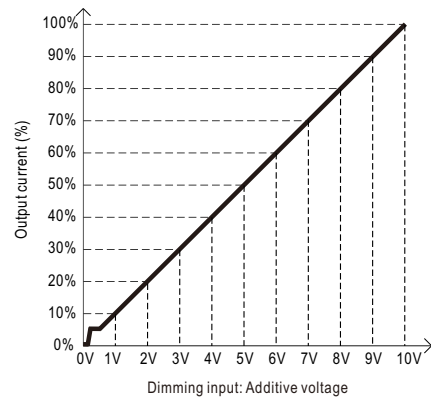
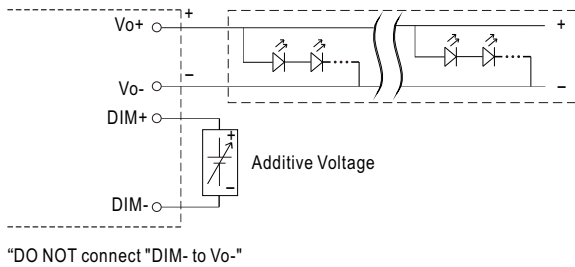

◎ Applying additive 10V PWM signal (frequency range 100Hz ~ 3KHz):

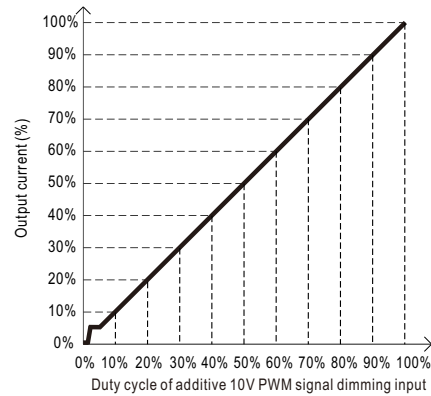
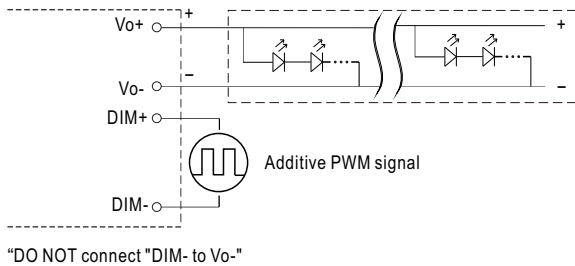

◎ Applying additive resistance:

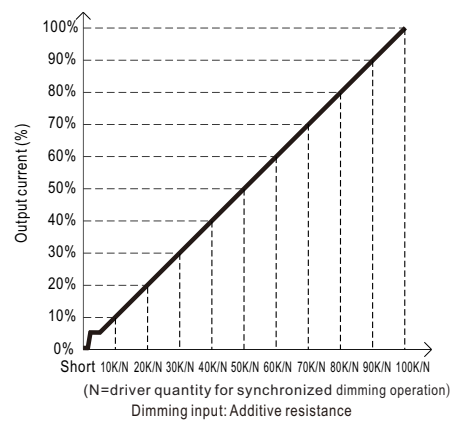
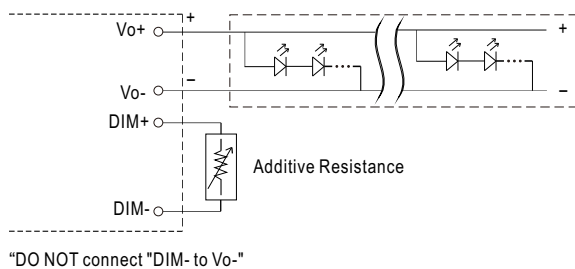

Note : 1. Min. dimming level is about 8% and the output current is not defined when 0% < I<sub>out</sub> < 8%.

2. The output current could drop down to 0% when dimming input is about 0k $\Omega$  or 0Vdc, or 10V PWM signal with 0% duty cycle.

**OUTPUT LOAD vs TEMPERATURE**

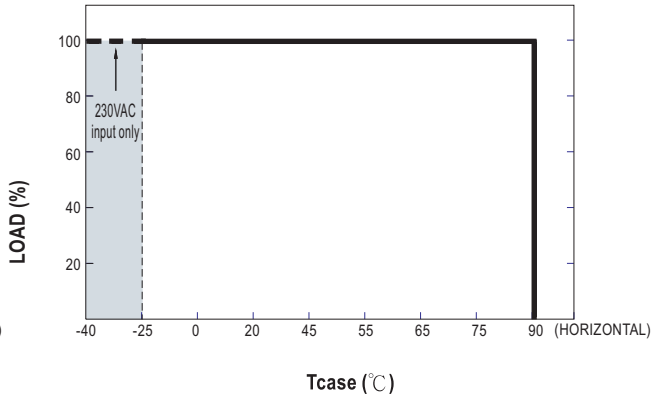
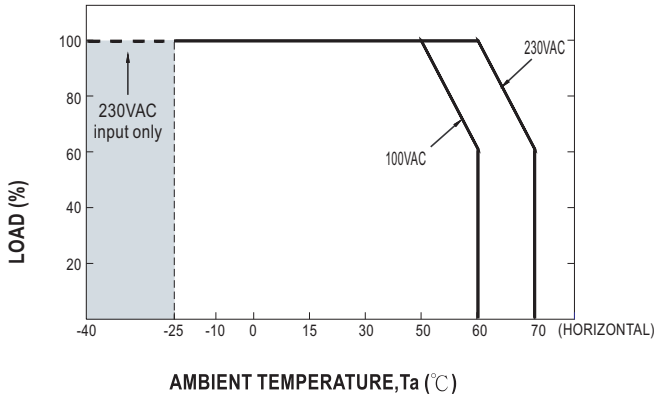

**STATIC CHARACTERISTIC**

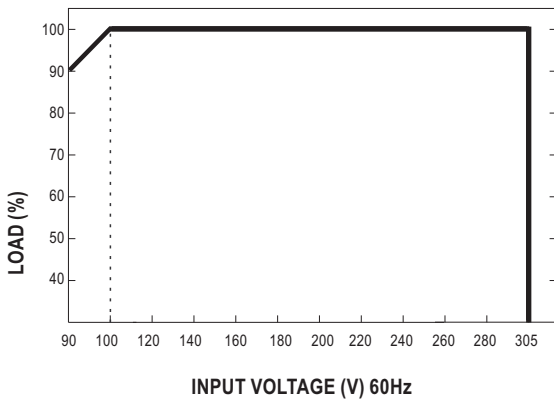

※ De-rating is needed under low input voltage.

**POWER FACTOR (PF) CHARACTERISTIC**

※ Tcase at 75°C

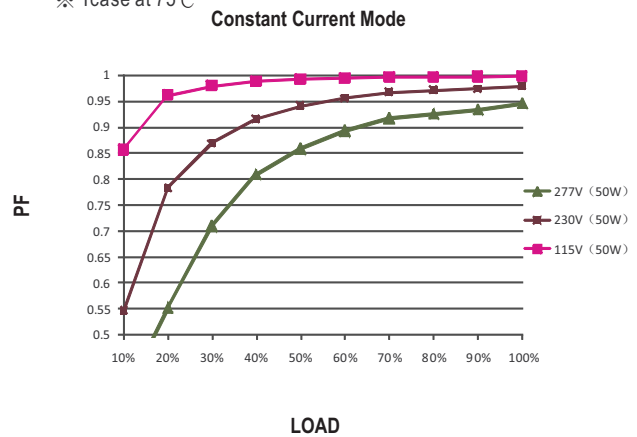

**TOTAL HARMONIC DISTORTION (THD)**

※ 50V Model, Tcase at 75°C

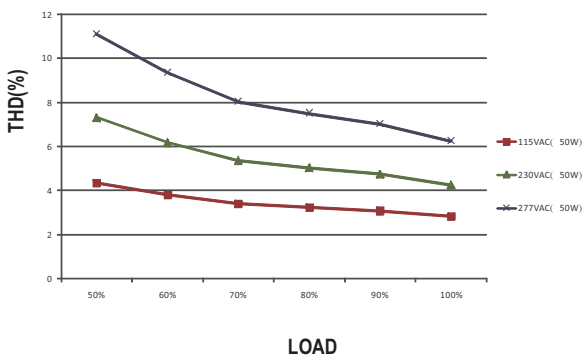

**EFFICIENCY vs LOAD**

XLG-50 series possess superior working efficiency that up to 90% can be reached in field applications.

※ 50V Model, Tcase at 75°C

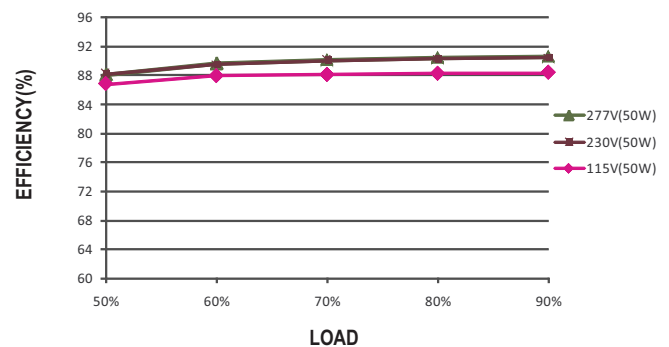



■ LIFE TIME

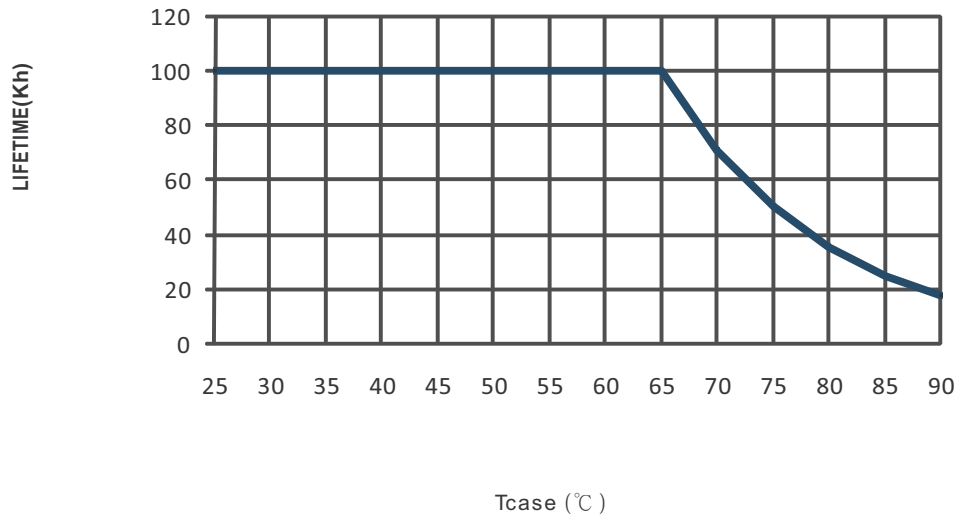

■ Mechanical Specification

※ A-Type

CASE NO.: 268A

Unit:mm

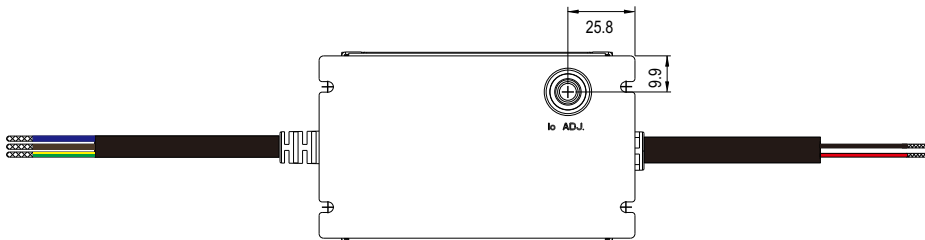
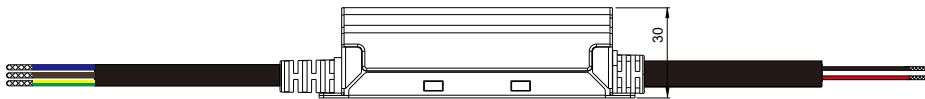
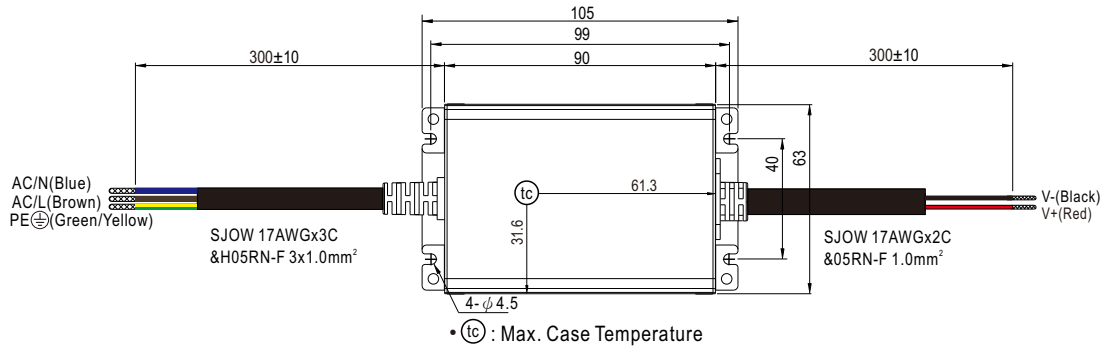

※ AB-Type

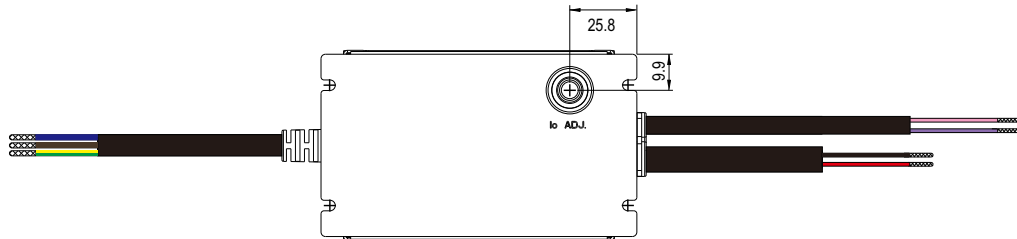
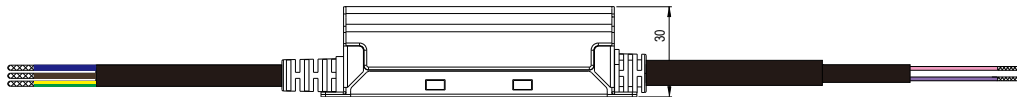
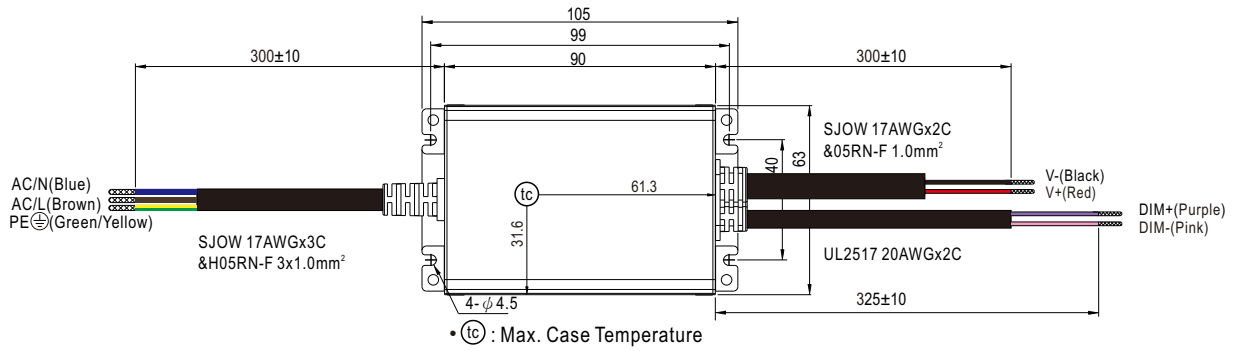

■ Recommend Mounting Direction

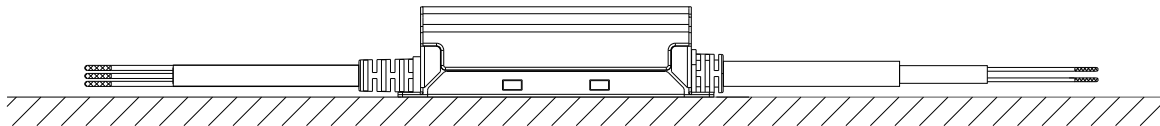

■ INSTALLATION MANUAL

Please refer to : <http://www.meanwell.com/manual.html>